

DVD PLAYER
LECTEUR DVD

DV-S6165

*OWNER'S MANUAL
MODE D'EMPLOI
MANUAL DE INSTRUCCIONES*

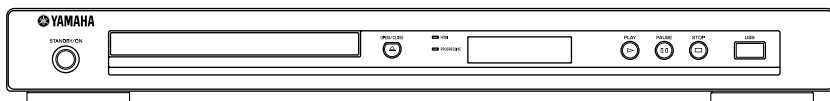

IMPORTANT SAFETY INSTRUCTIONS

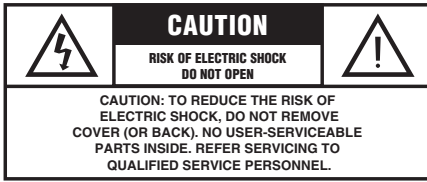

■ Explanation of Graphical Symbols



The lightning flash with arrowhead symbol, within an equilateral triangle, is intended to alert you to the presence of uninsulated "dangerous voltage" within the product's enclosure that may be of sufficient magnitude to constitute a risk of electric shock to persons.



The exclamation point within an equilateral triangle is intended to alert you to the presence of important operating and maintenance (servicing) instructions in the literature accompanying the appliance.

- 1 Read these instructions.
- 2 Keep these instructions.
- 3 Heed all warnings.
- 4 Follow all instructions.
- 5 Do not use this apparatus near water.
- 6 Clean only with dry cloth.
- 7 Do not block any ventilation openings. Install in accordance with the manufacturer's instructions.
- 8 Do not install near any heat sources such as radiators, heat registers, stoves, or other apparatus (including amplifiers) that produce heat.
- 9 Do not defeat the safety purpose of the polarized or grounding-type plug. A polarized plug has two blades with one wider than the other. A grounding type plug has two blades and a third grounding prong. The wide blade or the third prong are provided for your safety. If the provided plug does not fit into your outlet, consult an electrician for replacement of the obsolete outlet.
- 10 Protect the power cord from being walked on or pinched particularly at plugs, convenience receptacles, and the point where they exit from the apparatus.
- 11 Only use attachments/accessories specified by the manufacturer.
- 12 Use only with the cart, stand, tripod, bracket, or table specified by the manufacturer, or sold with the apparatus. When a cart is used, use caution when moving the cart/apparatus combination to avoid injury from tip-over.
- 13 Unplug this apparatus during lightning storms or when unused for long periods of time.
- 14 Refer all servicing to qualified service personnel. Servicing is required when the apparatus has been damaged in any way, such as power supply cord or plug is damaged, liquid has been spilled or objects have fallen into the apparatus, the apparatus has been exposed to rain or moisture, does not operate normally, or has been dropped.
- 15 Battery usage CAUTION - To prevent battery leakage which may result in bodily injury, property damage, or damage to the unit:
 - Install all batteries correctly, + and - as marked on the unit.
 - Do not mix batteries (old and new or carbon and alkaline, etc.).
 - Remove batteries when the unit is not used for a long time.
- 16 Apparatus shall not be exposed to dripping or splashing.
- 17 Do not place any sources of danger on the apparatus (e.g. liquid filled objects, lighted candles).



FCC INFORMATION (for US customers)

1. **IMPORTANT NOTICE: DO NOT MODIFY THIS UNIT!**

This product, when installed as indicated in the instructions contained in this manual, meets FCC requirements. Modifications not expressly approved by Yamaha may void your authority, granted by the FCC, to use the product.

2. **IMPORTANT:** When connecting this product to accessories and/or another product use only high quality shielded cables.

Cable/s supplied with this product **MUST** be used. Follow all installation instructions. Failure to follow instructions could void your FCC authorization to use this product in the USA.

3. **NOTE:** This product has been tested and found to comply with the requirements listed in FCC Regulations, Part 15 for Class "B" digital devices.

Compliance with these requirements provides a reasonable level of assurance that your use of this product in a residential environment will not result in harmful interference with other electronic devices. This equipment generates/uses radio frequencies and, if not installed and used according to the instructions found in the users manual, may cause interference harmful to the operation of other electronic devices. Compliance with FCC regulations does not guarantee that interference will not occur in all installations. If this product is found to be the source of interference, which can be determined by turning the product "OFF" and "ON", please try to eliminate the problem by using one of the following measures:

Relocate either this product or the device that is being affected by the interference.

Utilize power outlets that are on different branch (circuit breaker or fuse) circuits or install AC line filter/s.

In the case of radio or TV interference, relocate/reorient the antenna. If the antenna lead-in is 300 ohm ribbon lead, change the lead-in to coaxial type cable.

If these corrective measures do not produce satisfactory results, please contact the local retailer authorized to distribute this type of product. If you can not locate the appropriate retailer, please contact Yamaha Electronics Corp., 6660 Orangethorpe Ave. Buena Park, CA90620.

The above statements apply **ONLY** to those products distributed by Yamaha Corporation of America or its subsidiaries.

We Want You Listening For A Lifetime



Yamaha and the Electronic Industries Association's Consumer Electronics Group want you to get the most out of your equipment by playing it at a safe level. One that lets the sound come through loud and clear without annoying blaring or distortion - and, most importantly, without affecting your sensitive hearing.

Since hearing damage from loud sounds is often undetectable until it is too late, Yamaha and the Electronic Industries Association's Consumer Electronics Group recommend you to avoid prolonged exposure from excessive volume levels.

For Customer Use:

Read carefully the information located at the rear panel of this unit and enter below the Serial No. Retain this information for future reference.

Model No. _____

Serial No. _____

CAUTION

Use of controls or adjustments or performance of procedures other than those specified herein may result in hazardous radiation exposure.

CLASS 1 LASER PRODUCT
LASER KLASSE 1 PRODUKT
LUOKAN 1 LASERLAITE
KLASS 1 LASER APPARAT
PRODUIT LASER DE CLASSE 1

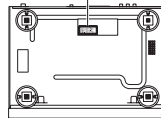

DANGER: AVOID DIRECT EXPOSURE TO THE BEAM
INVISIBLE LASER RADIATION WHEN OPEN
CAUTION: DO NOT STARE INTO BEAM
INVISIBLE LASER RADIATION WHEN OPEN

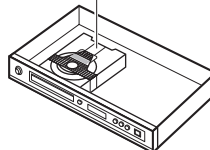

CAUTION: READ THIS BEFORE OPERATING THIS UNIT.

- 1 To assure the finest performance, please read this manual carefully. Keep it in a safe place for future reference.
- 2 Install this unit in a well ventilated, cool, dry, clean place — away from direct sunlight, heat sources, vibration, dust, moisture, or cold. In a cabinet, allow about 2.5 cm (1 inch) of free space all around this unit for adequate ventilation.
- 3 Locate this unit away from other electrical appliances, motors, or transformers to avoid humming sounds.
- 4 Do not expose this unit to sudden temperature changes from cold to hot, nor locate this unit in an environment with high humidity (i.e., a room with a humidifier) to prevent condensation inside this unit, which may cause an electrical shock, fire, damage to this unit, and/or personal injury.
- 5 Avoid installing this unit in a location where foreign objects may fall onto this unit or where this unit may be exposed to liquid dripping or splashing. On the top of this unit, do not place:
 - Other components, as they may cause damage and/or discoloration on the surface of this unit.
 - Burning objects (i.e., candles), as they may cause fire, damage to this unit, and/or personal injury.
 - Containers with liquid in them, as they may fall, spilling the liquid and causing an electrical shock to the user and/or damage to this unit.
- 6 Do not cover this unit with a newspaper, tablecloth, curtain, etc. in order not to obstruct heat radiation. If the temperature inside this unit rises, it may cause fire, damage to this unit, and/or personal injury.
- 7 Do not plug in this unit to a wall outlet until all connections are complete.
- 8 Do not operate this unit upside-down. It may overheat, possibly causing damage.
- 9 Do not use excessive force on switches, knobs and/or cords.
- 10 When disconnecting the power cord from the wall outlet, grasp the plug; do not pull the cord.
- 11 Do not clean this unit with chemical solvents; this might damage the finish. Use a clean, dry cloth.
- 12 Use only the voltage specified on this unit. Using this unit with a higher voltage than specified is dangerous and may cause fire, damage to this unit, and/or personal injury. Yamaha will not be held responsible for any damage resulting from use of this unit with a voltage other than as specified.
- 13 Do not attempt to modify or fix this unit. Contact qualified Yamaha service personnel when any service is needed. The cabinet should never be opened for any reason.
- 14 When not planning to use this unit for long periods of time (i.e., vacation), disconnect the AC power plug from the wall outlet.
- 15 Be sure to read the “Troubleshooting” section on common operating errors before concluding that this unit is faulty.
- 16 Before moving this unit, press STANDBY/ON to set the unit in standby mode, then disconnect the AC power plug from the wall outlet.
- 17 Install this unit near the AC outlet and where the AC power plug can be reached easily.
- 18 The batteries shall not be exposed to excessive heat such as sunshine, fire or the like.

The unit is not disconnected from the AC power source as long as it is connected to the wall outlet, even if this unit itself is turned off. This state is called the standby mode. In this state, this unit is designed to consume a very small quantity of power.

FOR CANADIAN CUSTOMERS

To prevent electric shock, match wide blade of plug to wide slot and fully insert.

This Class B digital apparatus complies with Canadian ICES-003.

WARNING

TO REDUCE THE RISK OF FIRE OR ELECTRIC SHOCK, DO NOT EXPOSE THIS UNIT TO RAIN OR MOISTURE.

LASER SAFETY

This unit employs a laser. Due to possible eye injury, only a qualified service person should remove the cover or attempt to service this device.

DANGER

This unit emits visible laser radiation when open. Avoid direct eye exposure to beam.

When this unit is plugged into a wall outlet, do not place your eyes close to the opening of the disc tray and other openings or look inside.

Introduction	3
About this manual	3
Supplied accessories	3
Region codes	3
Playable disc formats	4
Cleaning discs.....	4
Patent information	5

Functional Overview	6
Front panel	6
Rear panel.....	7
Remote control.....	8

Connections	9
General notes on connections	9
Audio connections	9
Digital connection	9
Analog connection.....	9
Video connections	10
Component video jacks <A>.....	10
S-video jack	10
Composite video jack <C>.....	10
SCART terminal <D> (Europe and Russia models only).....	10
HDMI connection	11
HDMI jack.....	11
Other connections	12
USB port.....	12
Remote control jacks.....	12

Getting Started	13
Step 1: Inserting batteries into the remote control	13
Using the remote control	13
Step 2: Turning on the power	13
Step 3: Setting a TV type/display and language	14
Setting a color system for your TV	14
Setting an aspect ratio for your TV	15
Setting the OSD Language.....	15
Setting the audio, subtitle, and disc menu languages (DVD-Video only)	16

Playback Operation	17
Basic operation	17
Selecting a track/chapter	17
Searching backward/forward	17
Repeat/Shuffle functions	17
Repeat/Shuffle playback	17
Repeating a section within a chapter/track	18
Operations for video playback (DVD/VCD/SVCD)	18
Using the disc menu.....	18
Playback in slow motion	18
Zooming pictures in/out	18
Resuming playback from the last stopped point	18
Using the on-screen display (OSD)	19
Special DVD features	20
Playing by title	20
Selecting an audio language/format and subtitle language	20
Special VCD/SVCD features	20
Using the playback control (PBC) menu	20
Playing data discs (MP3/WMA/WMV/JPEG/DivX®)	21
Selecting a folder and track/file	21
Special picture disc features	21
Using the preview function.....	21
Zooming pictures in/out	22
Playback with multi-angles.....	22
Playing MP3 music and JPEG pictures simultaneously	22
Special DivX® features	22
Using the interactive menu	22
Selecting an audio/subtitle language.....	22
Using a USB device	23
Supported USB devices	23
Playing data files.....	23

Contents

Setup Menu	25
Menu overview	25
Setup menu operation	27
General setup menu	28
Locking/Unlocking the disc for viewing	28
Recording CD tracks onto your USB device	28
Programming disc tracks (except MP3/WMA/WMV/JPEG/DivX®)	30
Dimming the front panel display	30
OSD language	30
Setting the screen saver	31
Setting the sleep timer	31
Displaying the DivX® VOD registration code	31
Audio setup menu	31
Setting the analog output	31
Setting the digital output	32
Turning the HDMI audio on/off	32
Turning the night mode on/off	33
Video setup menu	33
TV type	33
Setting the TV display	33
Turning the progressive scan function on/off	34
Adjusting picture settings	34
Turning the black level on/off	35
Turning the closed caption on/off	35
Switching YUV/RGB (Europe and Russia models only)	36
Setting the HDMI video	36
Preference setup menu	37
Audio, subtitle and disc menu	37
Restricting playback with parental control	37
Selecting playback of VR format	38
Selecting the data disc menu	38
Selecting DivX® external subtitle group (except Korea model)	38
Selecting the PBC (playback control) function	39
Setting the auto standby function	39
Changing the password	40
Resetting the system	40

Language Codes	41
Troubleshooting	42
Glossary	46
Specifications	48

Europe model

Information for Users on Collection and Disposal of Old Equipment and used Batteries



These symbols on the products, packaging, and/or accompanying documents mean that used electrical and electronic products and batteries should not be mixed with general household waste. For proper treatment, recovery and recycling of old products and used batteries, please take them to applicable collection points, in accordance with your national legislation and the Directives 2002/96/EC and 2006/66/EC. This symbol mark is according to the EU directive 2002/96/EC.



By disposing of these products and batteries correctly, you will help to save valuable resources and prevent any potential negative effects on human health and the environment which could otherwise arise from inappropriate waste handling.

For more information about collection and recycling of old products and batteries, please contact your local municipality, your waste disposal service or the point of sale where you purchased the items.



Pb

[Information on Disposal in other Countries outside the European Union]

These symbols are only valid in the European Union. If you wish to discard these items, please contact your local authorities or dealer and ask for the correct method of disposal.

Note for the battery symbol (bottom two symbol examples):

This symbol might be used in combination with a chemical symbol. In this case it complies with the requirement set by the Directive for the chemical involved.

About this manual

Thank you for purchasing this unit. This owner's manual explains the basic operation of this unit.

- Illustrations in this manual are based on the Europe model unless otherwise specified.
- Notes contain important information about safety and operating instructions.
-  indicates a tip for your operation.
- This manual is printed prior to production. Design and specifications are subject to change in part as a result of improvements, etc. In case of differences between the manual and the product, the product has priority.

Supplied accessories

For Europe and Russia models















- Remote control
- Two batteries (AAA, R03, UM-4) for the remote control
- RCA stereo cable
- Composite video cable

For U.S.A., Canada, Central and South America, Australia, Asia, and Korea models

- Remote control
- Two batteries (AAA, R03, UM-4) for the remote control
- Audio/video cable

Region codes

This unit is designed to support the region management system. Check the regional code number on the DVD disc package. If the number does not match the region code of this unit (see the table below or the back of this unit), this unit may be unable to play the disc.

Destination	Region code of this unit	Playable discs
U.S.A., Canada		 
Europe		 
Asia, Korea		 
Australia, Central and South America		 
Russia		 

Introduction

Playable disc formats

This unit is designed for use with discs having the logos shown below. Do not attempt to load any other type of disc into this unit.



This unit can play:

- DVD-R/RW/R DL and DVD+R/RW/R DL discs recorded in DVD-Video compatible format
- DVD-R/RW discs recorded in VR format (compatible with CPRM)
- MP3, WMA, WMV, and JPEG files recorded on CD-R/RW, DVD-R/RW, DVD+R/RW, and USB device
- KODAK picture CDs, FUJICOLOR CDs
- ISO 9660 Level1/Level2 for CD-R/RW
- Up to 298 folders per disc/USB device and up to 648 files per folder with up to 8 hierarchies
- DivX® files recorded on CD-R/RW, DVD-R/RW, DVD+R/RW, and USB device
 - Official DivX® Ultra Certified product
 - Plays all versions of DivX® video (including DivX® 6) with enhanced playback of DivX® media files and the DivX Media Format

Notes

- CD-R/RW, DVD-R/RW/R DL, and DVD+R/RW/R DL cannot be played unless finalized.
- Progressive JPEG, copyright-protected WMA and WMV files cannot be played with this unit.
- This unit is not compatible with WMV Advanced profile.
- Only the first session of DVD-R/RW/R DL and DVD+R/R DL can be played.
- Discs without logos shown left are not guaranteed to function.
- Some discs cannot be played depending on disc characteristics or recording conditions even if they have the logos shown left.
- Do not use any non-standard shaped discs (heart-shaped, etc.).
- Do not use discs with tape, seals, paste or many scratches on their surface.



For details about playable formats, see “Specifications” on page 48.

Cleaning discs

- When a disc becomes dirty, clean it with a cleaning cloth. Wipe the disc from the center out. Do not wipe in a circular motion.
- Do not use solvents such as benzine, thinner, commercially available cleaners, or antistatic spray intended for analog records.

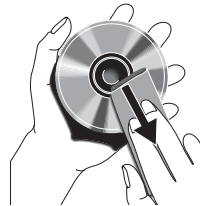

Patent information



Manufactured under license from Dolby Laboratories. Dolby and the double-D symbol are trademarks of Dolby Laboratories.



Manufactured under license under U.S. Patent No's : 5,451,942 and other U.S. and worldwide patents issued and pending. DTS and DTS Digital Out are registered trademarks and the DTS logos and Symbol are trademarks of DTS, Inc. Copyright 1996-2007 DTS, Inc. All Rights Reserved.



DivX, DivX Ultra Certified, and associated logos are trademarks of DivX, Inc. and are used under license.



HDMI, the HDMI logo and High-Definition Multimedia Interface are trademarks or registered trademarks of HDMI Licensing LLC.

This product incorporates copyright protection technology that is protected by U.S. patents and other intellectual property rights. Use of this copyright protection technology must be authorized by Macrovision, and is intended for home and other limited viewing uses only unless otherwise authorized by Macrovision. Reverse engineering or disassembly is prohibited.

Functional Overview

Front panel

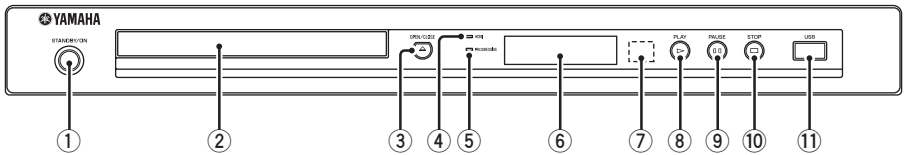

① **STANDBY/ON**

Turns on this unit or sets it to the standby mode (see page 13). In the standby mode, this unit consumes a small amount of power in order to receive infrared signals from the remote control.

② **Disc tray**

Loads a disc in the disc tray (see page 17).

③ **OPEN/CLOSE (△)**

Opens or closes the disc tray (see page 17).

④ **HDMI indicator**

Lights up when an HDMI component is connected and signals output via the HDMI jack of this unit.

⑤ **PROGRESSIVE indicator**

Lights up when this unit is in the progressive mode (see page 34).

⑥ **Front panel display**

Shows the current status of this unit.

⑦ **Remote control sensor**

Receives infrared signals from the remote control (see page 13).

⑧ **PLAY (▶)**

Starts playback.

⑨ **PAUSE (▢▢)**

Pauses playback.

Frame-by-frame playback (see page 17).

⑩ **STOP (□)**

Stops playback.

⑪ **USB port**

Connect the USB connector of your USB device (see page 12).

Rear panel

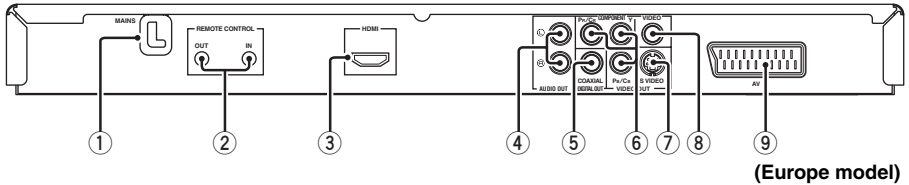

(Europe model)

- ① **AC power cable**
Plug the power cable into the AC wall outlet.
- ② **REMOTE CONTROL (IN, OUT) jacks**
Connect the REMOTE CONTROL (IN) jack of this unit to the remote control output jack of your Yamaha AV receiver (see page 12).
Connect the REMOTE CONTROL (OUT) jack of this unit to the remote control input jack of your Yamaha component.
- ③ **HDMI jack**
Connect to the HDMI input jack of your HDMI component (see page 11).
- ④ **AUDIO OUT (L, R) jacks**
Connect to the audio input jacks of your AV receiver or stereo system (see page 9).
- ⑤ **DIGITAL OUT - COAXIAL jack**
Connect to the coaxial input jack of your AV receiver (see page 9).
- ⑥ **VIDEO OUT - COMPONENT (Y, PB/CB, PR/CR) jacks**
Connect to the component input jacks of your AV receiver (see page 10).
- ⑦ **VIDEO OUT - S VIDEO jack**
Connect to the S-video input jack of your AV receiver (see page 10).
- ⑧ **VIDEO OUT - VIDEO jack**
Connect to the composite video input jack of your AV receiver (see page 10).
- ⑨ **AV terminal**
(Europe and Russia models only)
Connect to the SCART input terminal of your TV (see page 10).

Caution: Do not touch the inner pins of the jacks on the rear panel of this unit.
Electrostatic discharge may cause permanent damage to this unit.

Functional Overview

Remote control

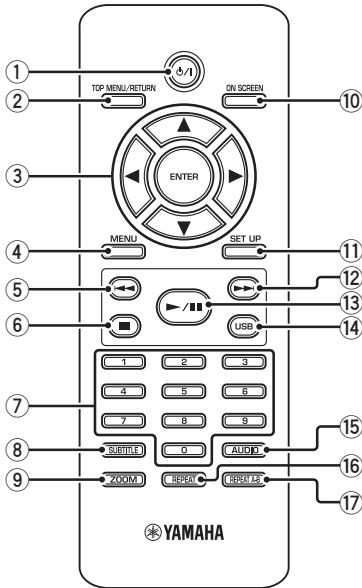

① ⏻/⏻

Turns on this unit or sets it to the standby mode (see page 13). In the standby mode, this unit consumes a small amount of power in order to receive infrared signals from the remote control.

② TOP MENU/RETURN

Displays the top-level disc menu (DVD). Moves back to the previous menu (DVD*/VCD) (see page 20).

③ ◀/▶/▲/▼

Selects an item in the currently displayed menu. Search or slow playback (see page 27).

ENTER

Confirms the menu selection (see page 27).

④ MENU

Displays the menu of a disc (DVD/JPEG) (see pages 18, 20, 21 and 22). Switches PBC on or off (VCD) (see page 20).

⑤ ⏮

Moves to the previous chapter or track (see page 17). Searches backward (see page 17).*

⑥ ■

Stops playback (see page 17). Opens the disc tray.*

⑦ Numeric buttons (0-9)

Selects numbered items in the currently displayed menu.

⑧ SUBTITLE

Selects the subtitle language (see pages 20 and 22).

⑨ ZOOM

Enlarges or shrinks the video image (see pages 18 and 22).

⑩ ON SCREEN

Accesses or exits from the on-screen display (OSD) menu of this unit (see page 19).

⑪ SET UP

Accesses or exits from the setup menu of this unit (see pages 14 and 27).

⑫ ▶▶

Moves to the next chapter or track (see page 17). Searches forward (see page 17).*

⑬ ▶/⏸

Starts or pauses playback (see page 17).

⑭ USB

Accesses the contents of the connected USB device or exits from the USB mode (see page 23).

⑮ AUDIO

Selects the audio language or format (see pages 20 and 22).

⑯ REPEAT

Accesses or exits from the repeat/shuffle mode (see page 17).

⑰ REPEAT A-B

Repeats a specified segment (see page 18).

* Press and hold the button for about two seconds.

General notes on connections

Be sure to turn off this unit and unplug the power cable before you make or change connections.

- Depending on the component you want to connect, there are various ways to make connections. Possible connections are described below.
- Refer to the manuals supplied with your other components as necessary to make the best connections.
- Do not connect this unit via your VCR. The video quality could be distorted by the copy protection system.
- Do not connect the audio out jack of this unit to the phono in jack of your audio system.

Audio connections

Digital connection

This unit has a digital coaxial output jack. Connect the DIGITAL OUT - COAXIAL jack of this unit to your AV receiver equipped with a Dolby Digital or DTS decoder using a commercially available coaxial digital audio cable.

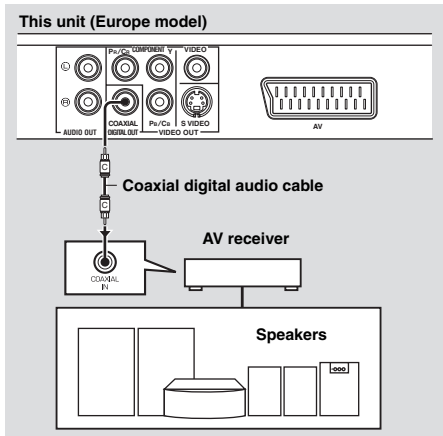

Notes

- You need to set [DIGITAL OUTPUT] to [ALL] (see “DIGITAL OUTPUT” on page 32).
- If the audio format of the digital output does not match the capabilities of your receiver, the receiver produces a distorted sound or no sound at all. Make sure to select the appropriate audio format from the menu screen on the disc. Pressing **AUDIO** on the remote control once or more may change not only the audio languages but also the audio format. The selected format appears on the TV screen for several seconds.
- If you want to enjoy Dolby Digital and DTS formats, you must connect this unit to an AV receiver that supports these formats.

Analog connection

This unit has 2-ch analog output jacks. Connect the AUDIO OUT (L, R) jacks of this unit to the corresponding input jacks of your audio component (such as a stereo amplifier) using the supplied RCA stereo cable (Europe and Russia models) or audio/video cable (other models).

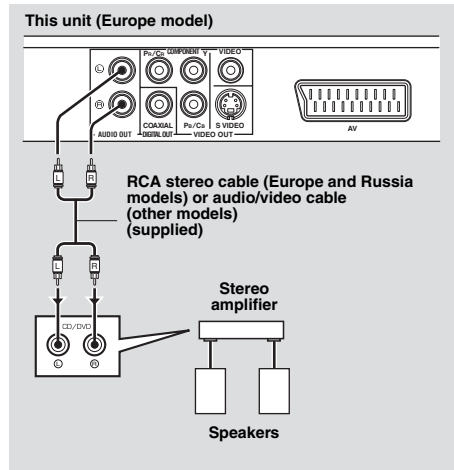

Connections

Video connections

Make video connections to your receiver and TV so that you can use one TV for several different video sources (LD, VCR, etc.) by simply switching the input source selector of your receiver.

This unit has several types of video output jacks. Use the one that corresponds to the input jacks of the component to be connected.

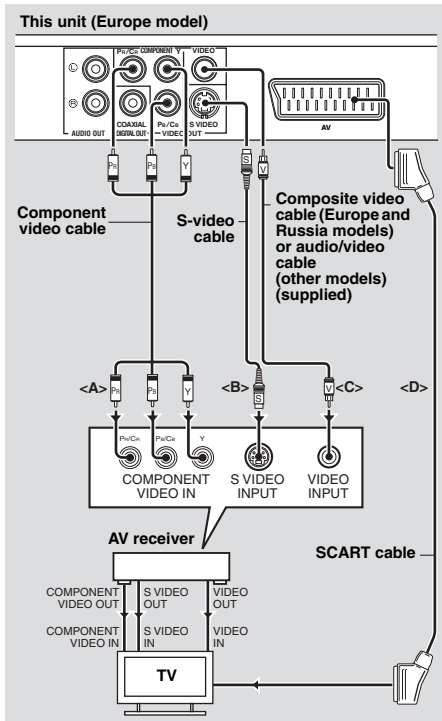

Component video jacks <A>

Component video connections achieve higher fidelity color reproduction than S-video connections by transmitting video signals on separate wires for luminance (Y: green) and chrominance (Pb: blue, Pr: red).

Connect the VIDEO OUT - COMPONENT (Y, Pb/Cb, Pr/Cr) jacks of this unit to component input jacks of your AV receiver and then to those of your TV using a

commercially available component video cable. Observe the color of each jack when you make connections.

If your receiver does not have component output jacks, you can achieve a better video image by connecting the component output jacks of this unit directly to the component input jacks of your TV.

S-video jack

S-video connections achieve a clearer picture than composite video connections by transmitting video signals on separate wires for luminance (Y) and chrominance (C). Connect the VIDEO OUT - S VIDEO jack of this unit to an S-video input jack of your AV receiver and then to that of your TV using a commercially available S-video cable.

Composite video jack <C>

Connect the VIDEO OUT - VIDEO jack of this unit to a video input jack of your AV receiver and then to that of your TV using the supplied composite video cable (Europe and Russia models) or audio/video cable (other models).

SCART terminal <D> (Europe and Russia models only)

You may connect the TV directly to this unit. Connect the AV terminal of this unit to the SCART input terminal of your TV using a commercially available SCART cable. The AV terminal outputs composite and RGB video signals together with 2-ch audio signal. Set the output of the video signal in "Switching YUV/RGB (Europe and Russia models only)" on page 36.

HDMI connection

HDMI jack

HDMI (High-Definition Multimedia Interface) provides high quality digital audio and video on a single connection.

Connect the HDMI jack of this unit to an HDMI input jack of your AV receiver, and then to that of your TV using a commercially available HDMI cable.

If your receiver does not have an HDMI input jack, you can achieve a better video image by connecting the HDMI jack of this unit directly to the HDMI input jack of your TV.

This unit can display High-Definition JPEG images (720p, 1080i, or 1080p) when you connect this unit to an HDTV via the HDMI jack. For details, see “HD JPEG” on page 37.

Notes

- You need to set [HDMI AUDIO] (see page 32) and [HDMI VIDEO] (see page 36) properly.
- You need to make appropriate audio connections if the connected component does not output audio signals (see “Audio connections” on page 9).
- This unit is not compatible with HDCP-incompatible HDMI or DVI components.
- You need a commercially available HDMI/DVI conversion cable when you connect this unit to other DVI components. In this case, the HDMI jack of this unit does not output any audio signals.
- Depending on the connected DVI component, black and white in the image may not be distinct. In that case, adjust the picture setting of the connected DVI component.
- Do not disconnect or turn off the power of the HDMI/DVI component connected to the HDMI jack of this unit during playback. Doing so may disrupt playback or cause noise.

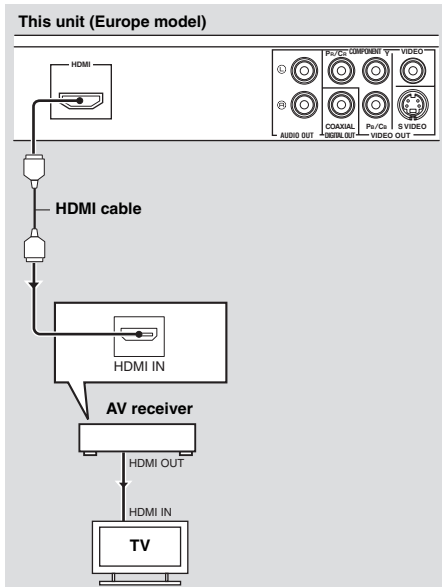

When connecting an HDMI component, refer to the manual supplied with your component.

Connections

Other connections

USB port

This unit has a USB port and can access MP3, WMA, WMV, JPEG, and DivX® files saved on your USB device.

Connect a USB connector of your USB device to the USB port on the front panel of this unit. When your USB device is connected to the USB port of this unit, you can record tracks on a CD onto your USB device in MP3 format. For details, see “Recording CD tracks onto your USB device” on page 28.

To disconnect the USB device, press **■** to stop playback, press **USB** to return to the disc mode, and then disconnect the device from this unit.

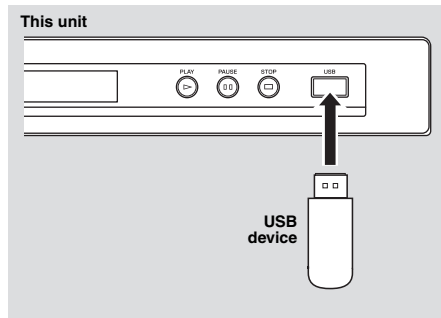

Note

This unit may not recognize some USB devices.



For details about the USB features, see “Using a USB device” on page 23.

Remote control jacks

This unit has remote control input/output jacks. If your AV receiver is a Yamaha product and has the capability to transmit SCENE control signals, you can use the SCENE function.

Connect the REMOTE CONTROL (IN) jack of this unit to a remote control output jack of your receiver using a commercially available monaural 3.5 mm mini plug cable so that this unit starts playback automatically by simply pressing a SCENE button of your receiver.

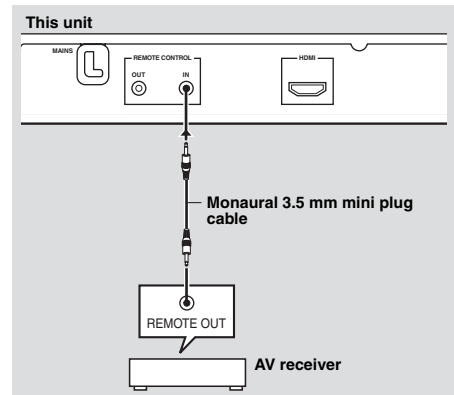

- For details about the SCENE function, refer to the owner's manual supplied with your Yamaha AV receiver.
- You can connect a Yamaha component (such as DVD player and CD player) corresponds with the SCENE function to the REMOTE CONTROL (OUT) jack of this unit.

Step 1: Inserting batteries into the remote control

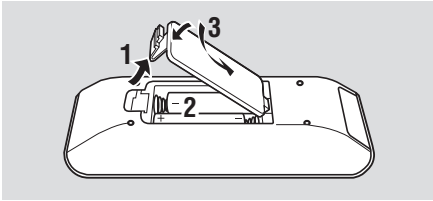

- 1 Open the battery compartment.
- 2 Insert the two supplied batteries (AAA, R03, UM-4) following the indications (+/-) inside the compartment.
- 3 Close the cover.

Notes

- Insert batteries correctly according to the polarity markings (+/-). Batteries inserted in the opposite orientation may leak.
- Replace the exhausted batteries immediately with new ones to prevent leakage.
- Remove the batteries from the compartment if the remote control is not used for more than a month.
- If the batteries have leaked, dispose of them immediately. Avoid touching the leaked material or letting it come into contact with clothing, etc. Clean the battery compartment thoroughly before installing new batteries.
- Do not use old batteries together with new ones.
- Do not use different types of batteries (such as alkaline and manganese batteries) together. Read the packaging carefully as these different types of batteries may have the same shape and color.
- Dispose of the batteries correctly in accordance with your local regulations.

Using the remote control

Use the remote control within 6 m (approximately 20 ft) of this unit and point it toward the remote control sensor.

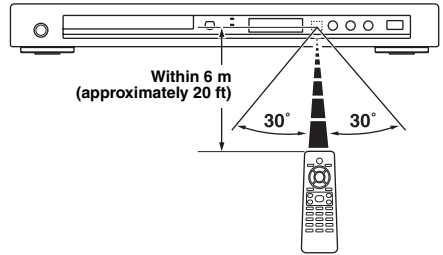

Notes

- Do not spill water or other liquids on the remote control.
- Do not drop the remote control.
- Do not leave or store the remote control in the following types of conditions:
 - places of high humidity, such as near a bath
 - places of high temperature, such as near a heater or stove
 - places of extremely low temperature
 - dusty places
- When the remote control works unstably, point it at an angle upward to the sensor.

Step 2: Turning on the power

- 1 Plug the power cable into the AC outlet.
- 2 Turn on your TV and AV receiver.
- 3 Select the appropriate input source of the AV receiver (refer to the manual supplied with your AV receiver).
- 4 Press **STANDBY/ON** on the front panel or **⏻/I** on the remote control to turn on this unit.
 - The front panel display lights up.
- 5 Set the TV to the correct video input (refer to the manual supplied with your TV).
 - The default screen appears on the TV.

Getting Started

Step 3: Setting a TV type/display and language

You can customize this unit using the setup menu displayed on the TV screen.

Note

Unless stated otherwise, all operations described here are carried out using the supplied remote control.



- To return to the previous menu, press ◀.
- If the setting you have selected are not appropriate, you can reset all settings to the initial factory settings (see “Resetting the system” on page 40).

Setting a color system for your TV

This unit is compatible with both NTSC and PAL video formats. Select the color system that matches your TV.

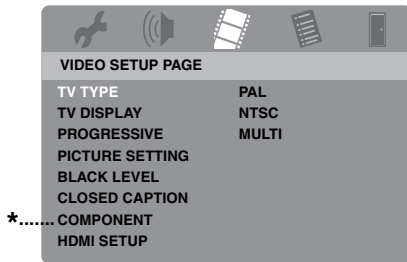

*: [COMPONENT] is only for Europe and Russia models.

- 1 Press **SET UP**.
- 2 Press ▶ repeatedly to select “VIDEO SETUP PAGE”.
- 3 Press ▲/▼ to highlight [TV TYPE], and then press ▶.
- 4 Press ▲/▼ to highlight one of the following options.

PAL

Select this if the connected TV is a PAL system TV. It will change the video signals of NTSC discs and output them in PAL format.

NTSC

Select this if the connected TV is an NTSC system TV. It will change the video signals of PAL discs and output them in NTSC format.

MULTI

Select this if the connected TV is compatible with both NTSC and PAL formats (such as a multi-system TV).

The output format will be in accordance with the video signals of the disc.

5 Select an item, and then press **ENTER**.

6 Press **SET UP** to exit from the menu.

Notes

- Before changing the current TV standard setting, ensure that your TV supports the selected TV type.
- When making HDMI connections, you cannot change or select [TV TYPE].



If the picture is not displayed properly on your TV, wait for 15 seconds for this unit to activate automatic recovery.

Setting an aspect ratio for your TV

You can set the aspect ratio of this unit to match your TV. If the aspect ratio of your TV is 16:9, you do not need to change this setting. For details, see “Setting the TV display” on page 33.

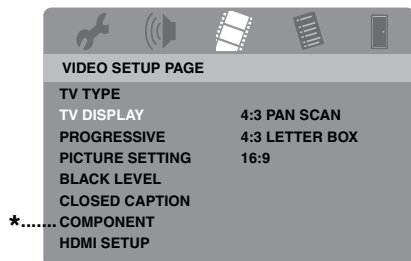

*: [COMPONENT] is only for Europe and Russia models.

- 1 Press **SET UP**.
- 2 Press **▶** repeatedly to select “VIDEO SETUP PAGE”.
- 3 Press **▲/▼** to highlight [TV DISPLAY], and then press **▶**.
- 4 Press **▲/▼** to highlight the desired setting, and then press **ENTER**.
- 5 Press **SET UP** to exit from the menu.

Setting the OSD Language

You can select your own preferred language for the setup menu. This setting remains once selected.

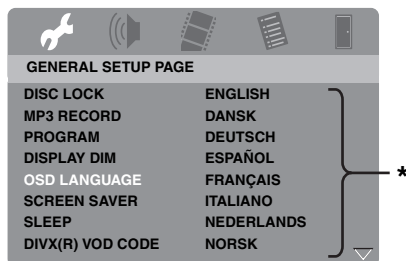

*: The menu items may change depending on the models.

- 1 Press **SET UP**.
- 2 Press **◀/▶** to select “GENERAL SETUP PAGE”.
- 3 Press **▲/▼** to highlight [OSD LANGUAGE], and then press **▶**.
- 4 Press **▲/▼** to select a language, and then press **ENTER**.
- 5 Press **SET UP** to exit from the menu.

Getting Started

Setting the audio, subtitle, and disc menu languages (DVD-Video only)

You can select your own preferred language for the audio, subtitle, and disc menu. This unit automatically switches to the selected language whenever you load a disc. If the selected language is not available on the disc, the default language of the disc will be used instead.

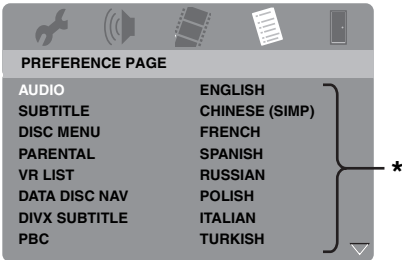

*: The menu items may change depending on the models.

■ To select a language not in the list

- 1 Select [OTHERS] in [AUDIO], [SUBTITLE], or [DISC MENU], and then press **ENTER**.
- 2 Use the **numeric buttons (0-9)** to enter the 4-digit language code (see "Language Codes" on page 41), and then press **ENTER**.
- 3 Press **SET UP** to exit from the menu.

- 1 Press **■** twice to stop playback (if necessary), and then press **SET UP**.
- 2 Press **▶** repeatedly to select "PREFERENCE PAGE".
- 3 Press **▲/▼** to highlight one of the options below, and then press **▶**.
 - AUDIO (audio language)
 - SUBTITLE (subtitle language)
 - DISC MENU (disc menu language)
- 4 Press **▲/▼** to select a language, and then press **ENTER**.
- 5 Repeat steps 3-4 for other language settings.
- 6 Press **SET UP** to exit from the menu.

Notes

- If the prohibited icon (⊘) appears on the TV screen when a button is pressed, the function for that button is not available on the current disc or at the current time.
- Depending on the disc, some operations may operate differently or be restricted. Refer to the instruction supplied with the disc.
- Do not push on the disc tray or put any objects other than discs on the disc tray. Doing so may cause this unit to malfunction.

Basic operation

- 1 Make sure this unit is turned on.
- 2 Press **OPEN/CLOSE** (△) on the front panel to open the disc tray.
- 3 Place the disc in the disc tray with the printed side up.
- 4 Press **OPEN/CLOSE** (△) again to close the disc tray.
 - After recognizing the disc, this unit starts playback automatically.
 - If you press ►/|| when the disc tray is open, the disc tray closes and playback starts automatically.
- 5 To pause playback, press ►/|| during playback.
 - Playback is paused and the sound is muted.
 - Frame-by-frame playback can be done by pressing **PAUSE** (⏏) on the front panel repeatedly.
- 6 To resume normal playback, press ►/|| again.
- 7 To stop playback, press ■.

Selecting a track/chapter

- 1 Press ◀◀/▶▶ or use the **numeric buttons (0-9)** to select a track/chapter number.
- 2 During repeated playback, press ◀◀/▶▶ to replay the same track/chapter.

Searching backward/forward

- 1 Press and hold ◀◀/▶▶ or press ◀/▶.
- 2 While searching, press ◀◀/▶▶ or ◀/▶ repeatedly to select the desired speed.
- 3 To resume normal playback, press ►/||.

Note

The ◀/▶ key may not be available with some discs.



For MP3, WMA, WMV, and DivX®, the search function allows you to search the track currently being played.

Repeat/Shuffle functions

Repeat/Shuffle playback

Each time you press **REPEAT** during playback, the front panel display changes as follows:

DVD-Video

- RPT ONE (repeat chapter)
- RPT TT (repeat title)
- RPT ALL (repeat all)
- SHUFFLE (shuffle)
- RPT SHF (shuffle repeat)
- RPT OFF (repeat off)

DVD VR format

- RPT ONE (repeat chapter)
- RPT TT (repeat title)
- RPT ALL (repeat all)
- RPT OFF (repeat off)

Playback Operation

VCD/SVCD/CD

- RPT ONE (repeat track)
- RPT ALL (repeat all)
- SHUFFLE (shuffle)
- RPT SHF (shuffle repeat)
- RPT OFF (repeat off)

MP3/WMA/WMV/DivX®

- RPT ONE (repeat file)
- RPT FLD (repeat folder)
- SHUFFLE (shuffle)
- RPT OFF (repeat off)

Note

For VCD/SVCD, repeat playback is not available when the PBC mode (see “Special VCD/SVCD features” on page 20) is on.

Repeating a section within a chapter/track

- 1 While playing a disc, press **REPEAT A-B** at the desired starting point.
 - “SET A” appears in the front panel display.
- 2 Press **REPEAT A-B** again at the desired end point.
 - A and B can only be set within the same chapter/track.
 - “RPT AB” appears in the front panel display and the selected section repeats continuously.
- 3 To exit from the sequence, press **REPEAT A-B**.

Operations for video playback (DVD/VCD/SVCD)

Using the disc menu

Depending on the disc, a menu may appear on the TV screen once you load the disc.

■ To select a playback feature or item

Use ◀/▶/▲/▼ or the **numeric buttons (0-9)**, and then press **ENTER** to start playback.

■ To access or exit from the menu

Press **MENU**.

Playback in slow motion

You can play back video in slow motion.

- 1 During playback, press ▲ for reverse slow motion or ▼ for forward slow motion.
- 2 During slow motion, press ▲/▼ repeatedly to select the desired speed.
- 3 To resume normal playback, press ▶/II.

Note

For VCD and SVCD, reverse slow motion is not available.

Zooming pictures in/out

You can enlarge or shrink the picture on the TV screen and pan through the enlarged picture.

- 1 During playback, press **ZOOM** repeatedly to display the picture at different scales.
 - Use ◀/▶/▲/▼ to pan through the enlarged picture.
 - Playback continues.
- 2 Press **ZOOM** repeatedly to return to the original size.

Resuming playback from the last stopped point

You can resume playback of the last ten discs, even if the discs were ejected or this unit was set to the standby mode.

- 1 Load one of the last ten discs.
→ “LOADING” appears on the TV screen.
- 2 Press ►/|| while “LOADING” is displayed on the TV screen.
→ “RESUME PLAY” appears on the TV screen and the disc is played back from the last point.

■ To cancel the resume mode

When playback is stopped, press ■ again.

Note

For DVD VR format, resume playback is not available.

Using the on-screen display (OSD)

The OSD menu shows disc playback information (e.g., the title or chapter number, elapsed playing time or audio/subtitle language). A number of operations are possible without interrupting disc playback.

- 1 During playback, press **ON SCREEN**.
→ A list of available disc information appears on the TV screen.

DVD

MENU		▶
TITLE	02/14	
CHAPTER	02/14	
AUDIO	5.1CH	
SUBTITLE	ENG	▼
BITRATE 16 III		TITLE ELAPSED 0:02:25

VCD/SVCD

MENU		▶
TRACK	02/14	
DISC TIME	0:49:17	
TRACK TIME	0:03:43	
REPEAT	OFF	▼
BITRATE 16 III		TOTAL ELAPSED 0:02:25

- 2 Press ▲/▼ to scroll the information, and then press **ENTER** to access the selected item.
- 3 Use the **numeric buttons (0-9)** to input the number/time or press ▲/▼ to make a selection, and then press **ENTER**.
→ Playback changes to the selected time/title/chapter/track.

■ Changing the Title/Chapter/Track (DVD/VCD)

- 1 Press ▲/▼ to select [TITLE], [CHAPTER] (DVD), or [TRACK] (VCD).
- 2 Press **ENTER**.
- 3 Select a title, chapter, or track number using the **numeric buttons (0-9)**.

■ Time search (DVD/VCD)

- 1 Press ▲/▼ to select [TT TIME] / [CH TIME] (DVD) or [DISC TIME] / [TRACK TIME] (VCD).
 - [TT TIME] refers to the total time of the current title, and [CH TIME] refers to the total time of the current chapter.
- 2 Press **ENTER**.
- 3 Enter hours, minutes and seconds from left to right using the **numeric buttons (0-9)** (e.g. 0:34:27).

■ Changing the Audio/Subtitle/Angle (DVD)

You can change [AUDIO], [SUBTITLE], or [ANGLE] if these functions are available on the disc you are playing.

- 1 Press ▲/▼ to select [AUDIO], [SUBTITLE], or [ANGLE].
- 2 Press **ENTER**.

Playback Operation

3 For Audio and Subtitle:

Press ▲/▼ to highlight your selection, and then press **ENTER**.

For Angle:

Select an angle using the **numeric buttons (0-9)**.

■ Repeat/Time Display (DVD/VCD)

1 Press ▲/▼ to select [REPEAT] or [TIME DISP.].

2 Press **ENTER**.

3 Press ▲/▼ to highlight your selection, and then press **ENTER**.

■ Time display (CD)

Each time you press **ON SCREEN**, the time display changes as follows:

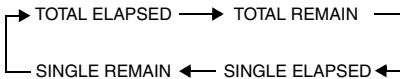

Note

Depending on the disc, the OSD menu may not be displayed even if you press **ON SCREEN**.

Special DVD features

Playing by title

1 Press **MENU**.

→ The disc title menu appears on the TV screen.

2 Use ◀/▶/▲/▼ or the **numeric buttons (0-9)** to select a playback option.

3 Press **ENTER**.

Selecting an audio language/format and subtitle language

■ To select an audio language/format

Press **AUDIO** repeatedly to select an audio language and/or format.

■ To select a subtitle language

Press **SUBTITLE** repeatedly to select a subtitle language.

Special VCD/SVCD features

Using the playback control (PBC) menu

For a VCD with a playback control (PBC) feature (version 2.0 only)

1 Press **MENU** to toggle between “PBC ON” and “PBC OFF”.

→ If you select “PBC ON”, the disc menu appears (if available) on the TV screen.

2 Use the **numeric buttons (0-9)** to select a playback option.

- Press ◀◀/▶▶ to move to the previous/next page (if available).

3 During playback, press **TOP MENU/RETURN** to return to the menu screen.

■ To skip the index menu and play back a disc from the beginning

Press **MENU** to turn off the PBC function.

Playing data discs (MP3/WMA/WMV/JPEG/DivX®)

- 1 Load a data disc.
 - The disc reading time may exceed 30 seconds due to the complexity of the directory/file configuration.
 - The data disc menu appears on the TV screen.

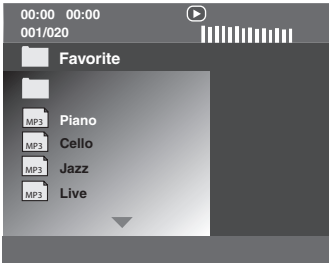

- 2 Playback starts automatically. If not, press **▶/II**.
- 3 Press **◀◀/▶▶** to select another track/file in the current folder.

Notes

- For JPEG, some files may not be displayed correctly depending on the aspect ratio of the image.
- It may not be possible to play certain MP3/WMA/WMV/JPEG/DivX® discs due to the configuration and characteristics of the discs or the recording conditions.
- HD JPEG images may not be displayed correctly when the first image is displayed or the disc is ejected. For details about HD JPEG, see “HD JPEG” on page 37.
- Depending on the picture size, HD JPEG images may appear smaller in size.

Selecting a folder and track/file

- 1 Press **▲/▼** to select a folder, and then press **ENTER** to open the folder.
- 2 Press **▲/▼** to select a track/file.
- 3 Press **ENTER**.
 - Playback starts from the selected file to the end of the folder.

Special picture disc features

- 1 Load a picture disc (JPEG, KODAK Picture CD, or FUJICOLOR CD).
 - For JPEG, the picture menu appears on the TV screen.
 - For KODAK Picture CD and FUJICOLOR CD, the slideshow begins.

■ For JPEG

- 2 Press **▶/II** to start the slideshow.

Using the preview function

This function displays the content of the current folder or the entire disc.

- 1 Press **■** during playback.
 - 12 thumbnails appear on the TV screen.

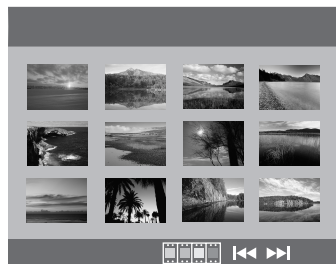

- 2 Press **◀◀/▶▶** to display the other thumbnails on the previous/next page.

Playback Operation

- 3 Use ◀/▶/▲/▼ to highlight one of the thumbnails, and then press **ENTER** to start playback.

OR

Move the cursor to highlight  on the bottom of the page and then press **ENTER** to start playback from the first thumbnail on the current page.

■ For JPEG

- 4 Press **MENU** to return to the data disc menu.

Zooming pictures in/out

- 1 During playback, press **ZOOM** repeatedly to display the picture at different scales.
- 2 Use ◀/▶/▲/▼ to pan through the enlarged picture.

Playback with multi-angles

During playback, press ◀/▶/▲/▼ to rotate the picture on the TV screen.

- ◀: rotates the picture counter-clockwise
- ▶: rotates the picture clockwise
- ▲: flips the picture vertically
- ▼: flips the picture horizontally

Playing MP3 music and JPEG pictures simultaneously

- 1 Load a disc that contains both MP3 music and JPEG picture data.
 - The disc menu appears on the TV screen.
- 2 Select an MP3 music track.

- 3 During MP3 music playback, select a JPEG picture file from the TV screen, and then press **ENTER**.
 - The picture files are played back one after another until the end of the folder.
- 4 To quit simultaneous playback, press **MENU**, and then press ■.

Notes

- Some files cannot be played correctly depending on disc characteristics or recording conditions.
- This function is not available when [HD JPEG] is set to [ON] (see page 37).

Special DivX® features

For DivX® files including DMF (DivX® Media Format) features only

Using the interactive menu

- 1 Load a disc and then select a file.
 - The interactive menu appears on the TV screen.
- 2 Use ◀/▶/▲/▼ to select a chapter.
- 3 Press **ENTER** or ▶/|| to start playback of the selected chapter.

■ To access the interactive menu

During playback, press **MENU**.

■ To return to the data disc menu screen

When the interactive menu is displayed, press ■.

Selecting an audio/subtitle language

■ To select an audio language

During playback, press **AUDIO** to switch the audio language recorded on the contents.

■ To select a subtitle language

During playback, press **SUBTITLE** to switch or turn on/off the subtitle language recorded on the contents.



- For information about external subtitle files, see “Selecting DivX® external subtitle group (except Korea model)” on page 38.
- For external subtitle files, the following subtitle format filename extensions are supported (note that these files are not shown within the disc menu): .srt, .sub, .ssa, .smi
- The filename of the movie file has to be repeated at the beginning of the filename for the external subtitle file.
- For Korean model, Korean and English external subtitle files are available.

Notes

- Some external subtitle files may be displayed incorrectly or not at all.
- Some discs cannot be played depending on disc characteristics or recording conditions.
- The number of external subtitle files that can be switched for the same movie file is limited to a maximum of ten.

Using a USB device

You can play back MP3, WMA, WMV, JPEG, and DivX® files saved on your supported USB device.

Supported USB devices

This unit supports USB mass storage class devices using FAT16 or FAT32 format. The supported devices are flash memories, card readers, and portable audio players.

Notes

- Some devices may not work properly.
- If “Device not supported” appears on the TV screen when you connect the USB device, follow the procedure below.
 - Set this unit to the standby mode, and then turn it on again.
 - Disconnect the device when this unit is in the standby mode, then connect it again and turn on this unit.
 - Connect the AC adapter if the adapter is supplied with the device.
- If “Device not supported” appears even after you perform this procedure, the device is not usable with this unit.
- If “USB current protection active. Device not supported” appears on the TV screen, the device is not usable with this unit because the power consumption of the device is too high.
- This unit cannot read more than two card reader slots at once, though it can recognize up to six slots. The first slot has priority.
- Do not connect devices other than USB mass storage class devices: USB chargers, USB hubs, PCs, etc.
- This unit is not compatible with HDDs.

Playing data files

- 1 Connect your USB device to the USB port of this unit (see “USB port” on page 12).
 - ➔ “Press USB key to switch device” appears on the TV screen.
- 2 Press **USB**.
 - The reading time may exceed 30 seconds due to the number of files/folders.
 - ➔ The file menu appears on the TV screen.
- 3 Follow the procedure in “Playing data discs (MP3/WMA/WMV/JPEG/DivX®)” on page 21.

Playback Operation

■ To exit from the USB mode

Press **■** to stop playback, and then press **USB**.

→ This unit is set to the disc mode.

■ To disconnect the USB device

After exiting from the USB mode, disconnect the USB device from this unit.

Notes

- Yamaha and suppliers accepts no liability for the loss of data saved on the USB devices connected to this unit. As a precaution, it is recommended that the files are made backup copies.
- You cannot access the USB mode while “LOADING” is displayed on the TV screen.
- If you disconnect the USB device or open the disc tray of this unit, the playback mode is automatically switched to the disc mode.
- This unit can display up to 648 files. However, less than 648 files may be displayed if some files are not playable with this unit.
- If the USB device is partitioned, only the first partition is displayed.
- This unit can play back files of 4 GB in size or less.

Menu overview

The bold items/parameters listed below are the default settings. The menu items, setting items, and default settings may change depending on the models.

Setup page	Menu item	Setting Item/Submenu	Setting item/Parameter	Page	
GENERAL SETUP PAGE	DISC LOCK	LOCK, UNLOCK		28	
	MP3 RECORD	(SETUP is displayed)		28	
	PROGRAM	(INPUT MENU is displayed)		30	
	DISPLAY DIM	100% , 70%, 40%		30	
	OSD LANGUAGE	(See "OSD LANGUAGE setting items" on page 26)		30	
	SCREEN SAVER	ON , OFF		31	
	SLEEP	30, 60, 90, 120, 150 MINS, OFF		31	
	DIVX(R) VOD CODE	(DivX® registration code is displayed)		31	
AUDIO SETUP PAGE	ANALOG OUTPUT	STEREO , LT/RT		31	
	DIGITAL AUDIO	DIGITAL OUTPUT	OFF, ALL , PCM ONLY	32	
		LPCM OUTPUT	48KHz , 96KHz	32	
	HDMI AUDIO	ON , OFF		32	
	NIGHT MODE	ON, OFF		33	
VIDEO SETUP PAGE	TV TYPE	PAL (Europe, Russia, Australia, and Asia models), NTSC (U.S.A., Canada, Central and South America, and Korea models), MULTI		33	
	TV DISPLAY	4:3 PAN SCAN, 4:3 LETTER BOX, 16:9		33	
	PROGRESSIVE	OFF , ON		34	
	PICTURE SETTING	STANDARD , BRIGHT, SOFT			34
		PERSONAL (BRIGHTNESS)	-20 to +20 (0)		34
		(CONTRAST)	-16 to +16 (0)		
		(TINT)	-9 to +9 (0)		
	(COLOR)	-9 to +9 (0)			
	BLACK LEVEL	ON , OFF			35
	CLOSED CAPTION	ON (U.S.A. and Canada models), OFF (Other models)			35
	COMPONENT (Europe and Russia models only)	YUV, RGB			36
HDMI SETUP	WIDE SCREEN FORMAT	SUPERWIDE , 4:3 PILLAR BOX, OFF		36	
	HDMI VIDEO	480P, 576P, 720P, 1080I, 1080P, AUTO		36	
	HD JPEG	ON, OFF		37	

Setup Menu

Setup page	Menu item	Setting Item/Submenu	Setting item/Parameter	Page
PREFERENCE PAGE	AUDIO	ENGLISH (Europe, U.S.A., Canada, Central and South America, Australia, and Asia models), RUSSIAN (Russia model), KOREAN (Korea model), etc.		37
	SUBTITLE	OFF (Europe, U.S.A., Canada, Central and South America, Australia, and Asia models), RUSSIAN (Russia model), KOREAN (Korea model), etc.		37
	DISC MENU	ENGLISH (Europe, U.S.A., Canada, Central and South America, Australia, and Asia models), RUSSIAN (Russia model), KOREAN (Korea model), etc.		37
	PARENTAL	1 KID SAFE, 2 G, 3 PG, 4 PG 13, 5 PGR, 6 R, 7 NC17, 8 ADULT		37
	VR LIST	ORIGINAL LIST , PLAY LIST		38
	DATA DISC NAV	WITHOUT MENU , WITH MENU		38
	DIVX SUBTITLE (except Korea model)	GROUP1 , GROUP2 , GROUP3 , GROUP4 , GROUP5		38
	PBC	ON , OFF		39
	AUTO STANDBY	ON , OFF		39
	PASSWORD	CHANGE		40
DEFAULT	RESET		40	

■ OSD LANGUAGE setting items

Model	Setting item
Europe	ENGLISH , DANSK , DEUTSCH , ESPAÑOL , FRANÇAIS , ITALIANO , NEDERLANDS , NORSK , POLSKI , PORTUGUÉS , РУССКИЙ , SVENSKA , TÜRKÇE
Russia	ENGLISH , DANSK , DEUTSCH , ESPAÑOL , FRANÇAIS , ITALIANO , NEDERLANDS , NORSK , POLSKI , PORTUGUÉS , РУССКИЙ , SVENSKA , TÜRKÇE
U.S.A., Canada	ENGLISH , FRANÇAIS , ESPAÑOL
Australia	ENGLISH , FRANÇAIS , ESPAÑOL
Central and South America	ENGLISH , ESPAÑOL , PORTUGUÉS
Asia	ENGLISH , 中文
Korea	한국어, ENGLISH

Setup menu operation

Setup is carried out on the TV, enabling you to customize this unit to suit your own particular requirements. Follow the procedures below to start the setup menu operations.



- To return to the previous menu, press ◀.
- The OSDs shown in this section are the examples of Europe model. The menu items, setting items, and default setting may change depending on the models.
- If the settings you have selected are not appropriate, you can reset all settings to the initial factory settings (see “Resetting the system” on page 40).
- Refer to the following pages for details of the menu that requires a particular operation.

1 Press **SET UP**.

→ The setup page and menu items appear on your TV.

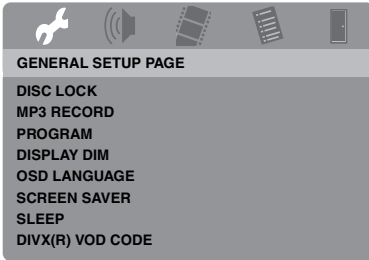

2 Press ◀/▶ to select the desired setup page.

3 Press ▲/▼ to highlight the desired menu item.

→ Menu items and setting items appear.

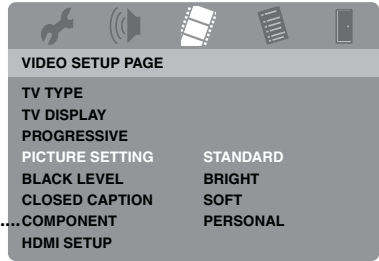

- *: [COMPONENT] is only for Europe and Russia models.

→ If setting items do not appear, the selected menu item has submenus. In this case, press **ENTER**, and then repeat step 3.

4 Press ▶.

5 Press ▲/▼ to select the desired setting item, and then press **ENTER**.

→ If the parameter appears, press ◀/▶ to adjust the setting, and then press **ENTER**.

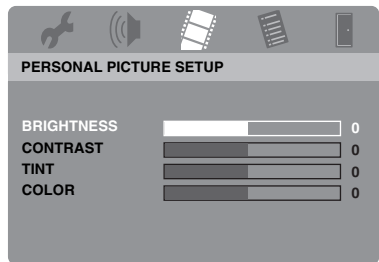

6 Press **SET UP** to exit from the menu.

Setup Menu

General setup menu

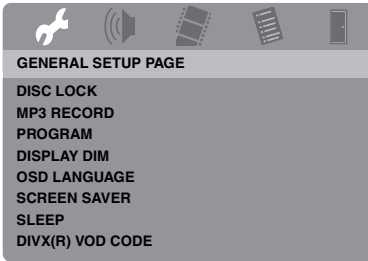

Locking/Unlocking the disc for viewing

Not all discs are rated or coded by the manufacturer of the disc. You can prevent playback of a specific disc by locking the disc. You can lock up to 40 discs on this unit.

- Select [DISC LOCK] in “GENERAL SETUP PAGE”.

LOCK

Select this to lock playback of the current disc. Subsequent access to a locked disc requires a six-digit password.

The default password is “000 000” (see “Changing the password” on page 40).

UNLOCK

Select this to unlock the disc and allow future playback.

Recording CD tracks onto your USB device

You can record CD tracks onto your USB device connected to this unit.

The tracks are recorded in MP3 format.

Notes

- MP3 files created by this unit are restricted to your private enjoyment only. Unauthorized use of copyrighted recordings can be copyright infringement.
- Yamaha and suppliers accepts no liability for the loss of data saved on the USB devices connected to this unit. As a precaution, it is recommended that the files are made backup copies.
- Discs incompatible with CDDA standard are not guaranteed to function.
- Copy protected music discs incompatible with CDDA standard are not recordable.
- Tracks protected by SCMS (Serial Copy Management System) are not recordable.
- If “USB current protection active. Device not supported” appears on the TV screen, the device is not usable with this unit because the power consumption of the device is too high.
- “Device not supported” or “USB current protection active. Device not supported” appears on the TV screen when you connect the USB device, this unit does not support the USB device. In this case, use a different USB device.
- During recording, do not disconnect your USB device or set this unit to the standby mode.



About the USB devices supported by this unit, refer to “Supported USB devices” on page 23.

- 1** Connect your USB device to the USB port of this unit (see “USB port” on page 12).
- 2** Load a music CD (see “Basic operation” on page 17).
- 3** In “GENERAL SETUP PAGE”, press ▲/▼ to highlight [MP3 RECORD], and then press ► to select [SETUP].
- 4** Press **ENTER**.

- 5 In “MP3 RECORD”, press ▲/▼ to highlight [SPEED], and then press **ENTER** repeatedly to select the desired setting.

MP3 RECORD			
OPTION		TRACK	
SPEED	Normal	Track 01	03:34
Bitrate	128 kbps	Track 02	06:42
		Track 03	03:42
		Track 04	03:09
		Track 05	02:50
		Track 06	00:34
		Track 07	05:15
			▼
SUMMARY			
Selected	0		
Total Time	00:00		
Start	Exit	Select All	Deselect All

Normal

Select this to record at normal speed.

Fast

Select this to record at about 2x speed.



When you select [Normal], you can enjoy playback while the recording.

- 6 Press ▲/▼ to highlight [Bitrate], and then press **ENTER** repeatedly to select the desired bit rate.

96 kbps, 128 kbps, 192 kbps, 256 kbps, 320 kbps

Select a bit rate for the music data.



Generally, the higher the bit rate, the better the sound quality. However, higher bit rates use more space on a device.

- 7 Press ►.

- 8 Press ▲/▼ to highlight the desired track in “TRACK”, and then press **ENTER**. Repeat this step as necessary to select the other tracks.

→ The number of selected tracks and total time are shown in “SUMMARY”.

- The tracks may be displayed on more than one page in “TRACK”. In this case, press ▲/▼ to select ▼ or ▲, and then press **ENTER** to scroll through pages.
- You can also select or deselect all the tracks by selecting [Select All] or [Deselect All].

- 9 Press ◀ to return to [SPEED].

- 10 Press ▲/▼ to highlight [Start], and then press **ENTER**.

- To cancel the recording, highlight [CANCEL], and then press **ENTER**.

Notes

- Recording cannot be started in the following conditions:
 - the connected USB device is not supported
 - no USB device is connected
 - when “USB current protection active. Device not supported” is shown on the TV screen
 - During recording, do not press any keys other than **ENTER**.
- 11 When the recording is completed, press ◀ / ▶ / ▲ / ▼ to highlight [Exit] and then press **ENTER** to exit from “MP3 RECORD” menu.



The created file is named as “TRACKxxx”. In “xxx”, numbers from 001 to 999 are inserted in order.

Setup Menu

Note

You cannot edit the files on your USB device connected to this unit by using this unit (for example, deleting or renaming the files).

Programming disc tracks (except MP3/WMA/WMV/JPEG/ DivX®)

You can play back the contents of a disc in the desired order by programming the tracks to be played. You can store up to 20 tracks per disc with a maximum of ten discs.

- 1 In “GENERAL SETUP PAGE”, press ▲/▼ to highlight [PROGRAM], and then press ► to select [INPUT MENU].
- 2 Press **ENTER**.
→ The input menu appears on the TV screen.

PROGRAM: TRACK (01-17)

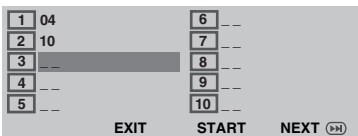

■ To input your favorite tracks/ chapters

- 3 Use the **numeric buttons (0-9)** to enter a valid track/chapter number.
- 4 Use ◀/▶/▲/▼ to move the cursor to the next position.
 - If the track/chapter number is more than ten, press ►► to move to the next page, and then proceed with programming.

OR

- Use ◀/▶/▲/▼ to highlight [NEXT] on the program menu, and then press **ENTER**.

- 5 Repeat steps **3-4** to input another track/chapter number.

■ To remove a track

- 6 Use ◀/▶/▲/▼ to select the track you want to remove.
- 7 Press **ENTER** to remove this track from the program menu.

■ To start program playback

- 8 Use ◀/▶/▲/▼ to highlight [START] on the program menu, and then press **ENTER**.
→ Playback starts for the selected tracks in the programmed sequence.

■ To exit from program playback

- 9 Use ◀/▶/▲/▼ to highlight [EXIT] on the program menu, and then press **ENTER**.

Dimming the front panel display

You can select different levels of brightness for the front panel display.

- Select [DISPLAY DIM] in “GENERAL SETUP PAGE”.

100%

Select this for full brightness.

70%

Select this for medium brightness.

40%

Select this for dimming display.

OSD language

This menu contains various options for the on-screen display (OSD) language. For details, see “Setting the OSD Language” on page 15.

Setting the screen saver

This function is used to turn on or off the screen saver.

- Select [SCREEN SAVER] in “GENERAL SETUP PAGE”.

ON

Select this to turn off the TV screen when disc playback is stopped or paused for more than 15 minutes.

OFF

Select this to disable the screen saver function.

Setting the sleep timer

This feature automatically sets this unit to the standby mode after a certain elapsed period.

- Select [SLEEP] in “GENERAL SETUP PAGE”.

30 MINS, 60 MINS, 90 MINS, 120 MINS, 150 MINS

Select one of them to set the sleep timer function.

OFF

Select this to cancel the sleep timer function.



The sleep timer setting can also be deactivated if this unit is set to the standby mode.

Displaying the DivX® VOD registration code

Yamaha provides you with a DivX® VOD (Video On Demand) registration code that allows you to rent and purchase videos using the DivX® VOD service.

For more information, visit
<https://vod.divx.com/>.

- 1 In “GENERAL SETUP PAGE”, press ▲/▼ to highlight [DIVX(R) VOD CODE], and then press ►.
→ The registration code appears.

- 2 Press **ENTER** to exit.



To purchase or rent the videos from DivX® VOD service at <https://vod.divx.com/>, use the registration code and download the video onto a CD-R for playback on this unit.

Notes

- All of the downloaded videos from DivX® VOD can only be played back on this unit.
- For DivX®, the time search feature is not available.

Audio setup menu

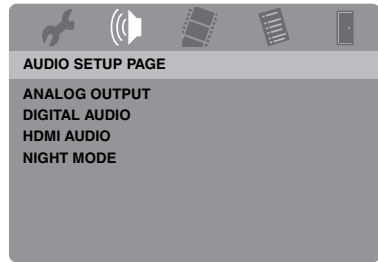

Setting the analog output

Set the analog output to match the playback capability of this unit.

- Select [ANALOG OUTPUT] in “AUDIO SETUP PAGE”.

STEREO

Select this to change channel output to stereo, which only delivers sound from the two front speakers.

LT/RT

Select this if this unit is connected to a Dolby Pro Logic decoder.

Setup Menu

Setting the digital output

The [DIGITAL AUDIO] options are: [DIGITAL OUTPUT] and [LPCM OUTPUT].

- 1 In “AUDIO SETUP PAGE”, press ▲/▼ to highlight [DIGITAL AUDIO], and then press ►.
- 2 Press ▲/▼ to highlight an option.
- 3 Press ►.

DIGITAL OUTPUT

Set the digital output according to your optional audio component connections.

OFF

Select this to turn off the digital output.

ALL

Select this if you have connected the digital audio output jack to a multi-channel decoder/receiver.

PCM ONLY

Select this only if your receiver is not capable of decoding multi-channel audio signals.



- Even if “ALL” is selected, this unit converts MPEG audio into 2 channel PCM and then outputs to the connected component.
- When “PCM ONLY” is selected, DTS digital signal is muted.

LPCM OUTPUT

Select this if you have connected this unit to a PCM-compatible receiver via a digital jack, such as the coaxial jack. In this case, you may need to adjust [LPCM OUTPUT].

Discs are recorded at a certain sampling rate. The higher the sampling rate, the better the sound quality.

48KHz

Select this to play back discs recorded at the sampling rate of 48 kHz. All 96 kHz PCM data streams (if available) are converted to the sampling rate of 48 kHz.

96KHz

Select this to play back discs recorded at the sampling rate of 96 kHz. If the 96 kHz disc is copy protected, the digital output is automatically converted to the sampling rate of 48 kHz. 48 kHz PCM data streams are output at 48 kHz.

- 4 Press ▲/▼ to select a setting, and then press **ENTER**.

Turning the HDMI audio on/off

When you connect this unit to an HDMI compatible component via the HDMI jack, select to turn on or off the HDMI audio output.

- Select [HDMI AUDIO] in “AUDIO SETUP PAGE”.

ON

Select this to turn on the HDMI audio output.

OFF

Select this to turn off the HDMI audio output.

Notes

- If you are not using the HDMI audio output, set this to [OFF].
- If the monitor/receiver connected to this unit using HDMI does not support HDMI audio signal input, set this to [OFF].
- When audio signals are being output by HDMI-compatible components, digital signals output at the coaxial jack of this unit are muted.
- When [DIGITAL OUTPUT] is set to [OFF] on this unit, HDMI audio signal is not output even if [HDMI AUDIO] is set to [ON] and an HDMI connection is established between the monitor and receiver.
- When [DIGITAL OUTPUT] is set to [ALL] on this unit, PCM signals are still output if the monitor and receiver only support the PCM format. However, the HDMI audio signal is muted when audio format plays back the DTS source.



This unit can output the following audio signals using HDMI: 32/44.1/48 kHz, 2ch linear PCM signals and bitstream signals (Dolby Digital and DTS).

Turning the night mode on/off

In the night mode, high volume output is softened and low volume output is brought upward to an audible level. It is useful when you want to watch your favorite action movie without disturbing others at night.

- Select [NIGHT MODE] in “AUDIO SETUP PAGE”.

ON

Select this to level out the volume. This feature is only available for movies with the Dolby Digital mode.

When you select this setting, invalidate the dynamic range compression (DRC) of the connected component.

OFF

Select this when you want to enjoy the full dynamic range of surround sound.

Video setup menu

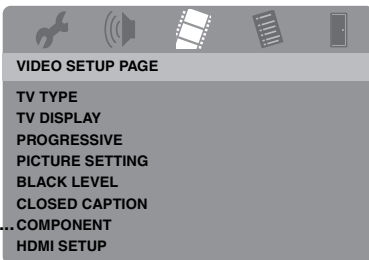

*: [COMPONENT] is only for Europe and Russia models.

TV type

This menu contains the options for selecting the color system that matches your TV. For details, see “Setting a color system for your TV” on page 14.

Setting the TV display

Set the aspect ratio of this unit to match your TV. The format you select must be available on the disc. Otherwise, the TV display setting will not affect the picture during playback.

- Select [TV DISPLAY] in “VIDEO SETUP PAGE”.

4:3 PAN SCAN

Select this if the aspect ratio of your TV is 4:3 and you want both sides of the picture to be trimmed or formatted to fit your TV screen.

4:3 LETTER BOX

Select this if the aspect ratio of your TV is 4:3. In this case, a wide picture with black bands on the upper and lower portions of the TV screen are displayed.

16:9

Select this if you have a widescreen TV.



■ The relationship between the setting of this unit and the TV display

When the aspect ratio of your TV is 4:3:

Setting	Playback disc	TV display	
4:3 PAN SCAN	16:9		*1
	4:3		
4:3 LETTER BOX	16:9		
	4:3		

Setup Menu

When the aspect ratio of your TV is 16:9 (widescreen):

Setting	Playback disc	TV display	
16:9	16:9		
	4:3		*2

*1: If the disc is not assigned to playback in panscan, it is played in letterbox.

*2: The side of the picture may be stretched depending on the TV. In this case, check the screen size and aspect ratio of your TV.

Turning the progressive scan function on/off

This feature is only available if you have connected this unit to a progressive scan TV through the component video jacks (see “Component video jacks <A>” on page 10).

- Select [PROGRESSIVE] in “VIDEO SETUP PAGE”.

OFF

Select this to disable the progressive scan function.

ON

Select this to enable the progressive scan function.

Notes on activating progressive scan:

- Ensure that your TV is equipped with progressive scan.
- Connect using a component video cable.
- When making HDMI connections, you cannot select [PROGRESSIVE].
- (Europe and Russia models only) When [COMPONENT] is set to [RGB] (see page 36), you cannot select [PROGRESSIVE].
- You can turn off the progressive scan without using the setup mode if no picture is displayed. See “No picture is displayed when you do not use progressive scan connections (using the component video jacks)” in “Troubleshooting” on page 43.

Adjusting picture settings

This unit comes with three predefined sets of picture color settings and one personal setting that you can define yourself.

- 1 In “VIDEO SETUP PAGE”, press ▲/▼ to highlight [PICTURE SETTING], and then press ►.

STANDARD

Select this for the standard picture setting.

BRIGHT

Select this to make the TV picture brighter.

SOFT

Select this to make the TV picture softer.

PERSONAL

Select this to personalize your picture color by adjusting the brightness, contrast, tint and color (saturation).

- 2 Press ▲/▼ to select a setting, and then press **ENTER**.

- 3 If you select [PERSONAL] in step 1, proceed to steps 4-7.

- The “PERSONAL PICTURE SETUP” menu appears.

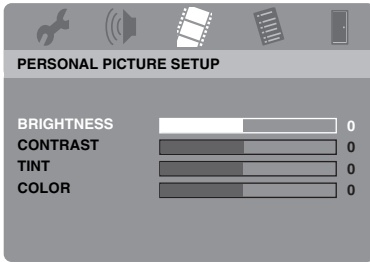

- 4 Press ▲/▼ to select one of the following options.

BRIGHTNESS

Adjust the brightness of the picture. Zero (0) is the average brightness setting value.

CONTRAST

Adjust the contrast of the picture. Zero (0) is the average contrast setting value.

TINT

Adjust the balance of red and green of the picture. Zero (0) is the average tint setting value.

COLOR

Adjust the color level of the picture. Zero (0) is the average color setting value.

- 5 Press ◀/▶ to adjust the setting that best suits your personal preference.
- 6 Repeat steps 4-5 to adjust other color features.
- 7 Press **ENTER**.

Turning the black level on/off

When [TV TYPE] is set to [NTSC] (see page 14), this menu is effective for improving the visibility of the black color in the dark area on the screen. The black level setting has no effect if [TV TYPE] is set to [PAL].

- Select [BLACK LEVEL] in “VIDEO SETUP PAGE”.

ON

Select this to improve the visibility of the black color.

OFF

Select this for the standard black level setting.

Note

This function is only available for composite video / S-video output.

Turning the closed caption on/off

Closed captions are data hidden in the video signals of specific discs and are invisible without the use of a special decoder. The difference between subtitles and captions is that subtitles are intended for hearing persons and captions are for the hearing impaired. Subtitles rarely show all of the audio. For example, captions show sound effects (e.g., “phone ringing”, “footsteps”), while subtitles do not.

Before you select this function, ensure that the disc contains closed caption information and your TV also supports this function.

- Select [CLOSED CAPTION] in “VIDEO SETUP PAGE”.

ON

Select this to enable the closed caption function.

OFF

Select this to disable the closed caption function.

Setup Menu

Note

This function is only available for NTSC video format and composite video / S-video output.

Switching YUV/RGB (Europe and Russia models only)

This setting allows you to toggle the output of the video signal between YUV (on VIDEO OUT - COMPONENT) and RGB (on SCART).

- Select [COMPONENT] in “VIDEO SETUP PAGE”.

YUV

Select this for the component video connection.

RGB

Select this for SCART connection.

Setting the HDMI video

When you connect this unit to an HDMI compatible component via the HDMI jack, select the following video output settings depending on the connected component.

- 1 In “VIDEO SETUP PAGE”, press ▲/▼ to highlight [HDMI SETUP], and then press ►.
- 2 Press ▲/▼ to highlight an option.
- 3 Press ► to enter a submenu.

WIDE SCREEN FORMAT

Set the aspect ratio of the projected images on the screen. This feature is only available when making HDMI connections and [TV DISPLAY] is set to [16:9] (see page 33) when playing back 4:3 image.

SUPERWIDE

Select to display a 4:3 image on the 16:9 screen with non-linear stretching (center position of screen is stretched less than the sides).

4:3 PILLAR BOX

Select to display a 4:3 image on the 16:9 screen without stretching. When playing a disc recorded in the 16:9 image, the image is displayed in its original aspect ratio (16:9) without pillar boxes.

OFF

No aspect ratio adjustment is made when this option is selected.

Note

When the video signal is 480p or 576p, you cannot select [WIDE SCREEN FORMAT], and no aspect ratio adjustment is made even if [SUPERWIDE] or [4:3 PILLAR BOX] is selected.

HDMI VIDEO

Set the resolution depending on the monitor you are using. This unit is compatible with the following video formats:

480p/60Hz, 576p/50Hz, 720p/50Hz, 60Hz, 1080i/50Hz, 60Hz, and 1080p/50Hz, 60Hz

480P

480 progressive-scan video

576P

576 progressive-scan video

720P

720 progressive-scan video

1080I

1080 interlaced video

1080P

1080 progressive-scan video

AUTO

The resolution is automatically selected to match the monitor you are using.

Notes

- For the settings other than [AUTO], images may not be displayed properly if a resolution output setting is not supported by the HDMI component you are using. In that case, follow the steps below to return to [AUTO].
 - Press **OPEN/CLOSE (Δ)** on the front panel to open the disc tray.
 - Press **◀**.
 - Press **SUBTITLE**.
- You cannot set [TV TYPE], [PROGRESSIVE], and [COMPONENT] (Europe and Russia models) when making HDMI connections.
- When disconnecting the HDMI cable, the setting of [TV TYPE] may be changed. If the component video, S-video, or composite video signal is not output correctly, see “Completely distorted picture, black/white picture, or no picture” in “Troubleshooting” on page 43 to set the correct TV type again.

HD JPEG

This unit can display High-Definition JPEG images when connecting to an HDMI component using HDMI cable.

ON

Displays JPEG pictures with high quality.

OFF

Displays JPEG pictures with standard quality.

Notes

- You can select [HD JPEG] when the HDMI video signals with 720p, 1080i, and 1080p are output.
- You cannot select [HDMI SETUP] when JPEG (including HD JPEG) pictures are displayed.

Preference setup menu

Press **■** twice to stop playback (if necessary) before pressing **SET UP**.

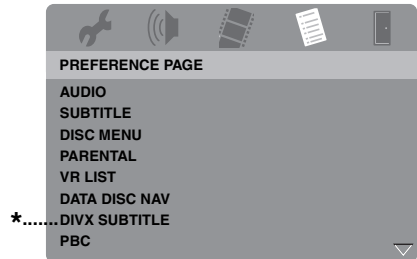

*: [DIVX SUBTITLE] is available for the models other than Korea model.

Audio, subtitle and disc menu

These menus contain various language options for the audio, subtitles, and disc menus recorded on the DVD-Video. For details, see “Setting the audio, subtitle, and disc menu languages (DVD-Video only)” on page 16.

Restricting playback with parental control

Some DVDs may have a parental level assigned to the complete disc or to certain scenes on the disc. This feature lets you set a playback limitation level. The rating levels are from 1 to 8 and are country dependent. You can prohibit playback of certain discs that are not suitable for your children or play certain discs in alternative scenes.

Setup Menu

- 1 In “PREFERENCE PAGE”, press ▲/▼ to highlight [PARENTAL], and then press ►.

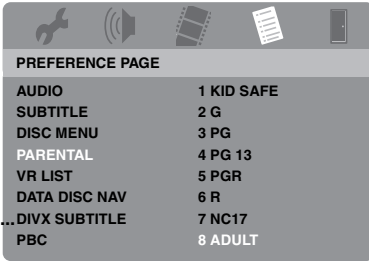

*: [DIVX SUBTITLE] is available for the models other than Korea model.

- 2 Press ▲/▼ to highlight a rating level for the inserted disc, and then press **ENTER**.
 - To disable parental controls and have all discs play, select [8 ADULT].
- 3 Use the **numeric buttons (0-9)** to enter the six-digit password (see “Changing the password” on page 40).
 - DVD discs that are rated above the level you selected do not play unless you enter your six-digit password.

Note

Some DVD discs are not encoded with a rating though the movie rating may be printed on the disc cover. The rating level feature does not work for such discs.

Selecting playback of VR format

There are two ways to play back a disc in VR (Video Recording) format: ORIGINAL and PLAY LIST.

- 1 In “PREFERENCE PAGE”, press ▲/▼ to highlight [VR LIST], and then press ►.

ORIGINAL LIST

Select this to play the originally recorded titles on the disc.

PLAY LIST

Select this to play the edited version of the disc. This feature is only available when a play list has been created.

- 2 Press ▲/▼ to highlight a setting, and then press **ENTER**.

■ To play back a disc in VR format

- 3 Press **SET UP** to close the setup menu.
- 4 Press ►/|| to begin to play back the disc with the setting you selected.

Selecting the data disc menu

Data disc navigator can be set only if the disc was recorded with a menu. It allows you to display folder menus when playing back a disc with folder structure.

- Select [DATA DISC NAV] in “PREFERENCE PAGE”.

WITHOUT MENU

Select this to display all the files contained in the data disc.

WITH MENU

Select this to display only the folder menu of the data disc.

Selecting DivX® external subtitle group (except Korea model)

The font sets listed below are available for DivX® external subtitle files. This setting allows you to see the proper font set on-screen to match the subtitle file.

- Select [DIVX SUBTITLE] in “PREFERENCE PAGE”.

GROUP1:

Albanian (sq), Basque (eu), Catalan (ca), Danish (da), Dutch (nl), English (en), Faroese (fo), Finnish (fi), French (fr), German (de), Icelandic (is), Irish (ga), Italian (it), Norwegian (no), Portuguese (pt), Rhaeto-Romanic (rm), Scottish (gd), Spanish (es), Swedish (sv)

GROUP2:

Albanian (sq), Croatian (hr), Czech (cs), Hungarian (hu), Polish (pl), Romanian (ro), Slovak (sk), Slovenian (sl)

GROUP3:

Bulgarian (bg), Byelorussian (be), Macedonian (mk), Russian (ru), Serbian (sr), Ukrainian (uk)

GROUP4:

Hebrew (iw), Yiddish (ji)

GROUP5:

Turkish (tr)

Notes

- Some external subtitle files may be displayed incorrectly or not at all.
- Some discs cannot be played depending on disc characteristics or recording conditions.
- The number of external subtitle files that can be switched for the same movie file is limited to a maximum of ten.



- For external subtitle files, the following subtitle format filename extensions are supported (note that these files are not shown within the disc menu): .srt, .sub, .ssa, .smi
- The filename of the movie file has to be repeated at the beginning of the filename for the external subtitle file.

Selecting the PBC (playback control) function

You can set playback control (PBC) to on or off. This function is available only on Video CD 2.0 with the playback control (PBC) feature.

- Select [PBC] in “PREFERENCE PAGE”.

ON

Select this to display a disc menu.

OFF

Select this not to display a disc menu.

Playback starts from the beginning of a disc.



You can also use the **MENU** button on the remote control to turn on or off the playback control (PBC) function (see “Using the playback control (PBC) menu” on page 20).

Setting the auto standby function

You can set auto standby function to on or off.

- Select [AUTO STANDBY] in “PREFERENCE PAGE”.

ON

Select this to set this unit to the standby mode automatically when disc playback is stopped or paused for more than 30 minutes.

OFF

Select this to disable the auto standby function.

Setup Menu

Changing the password

The same password is used for both parental control and disc lock. Enter your six-digit password when prompted on the screen. The default password is 000 000.

- 1 In “PREFERENCE PAGE”, press ▲/▼ to highlight [PASSWORD], and then press ► to select [CHANGE].

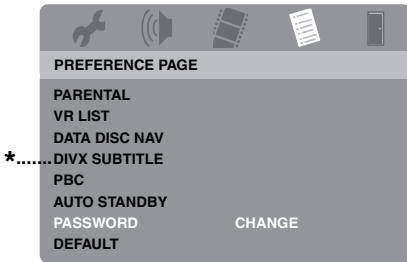

*: [DIVX SUBTITLE] is available for the models other than Korea model.

- 2 Press **ENTER** to enter the “Password Change Page”.

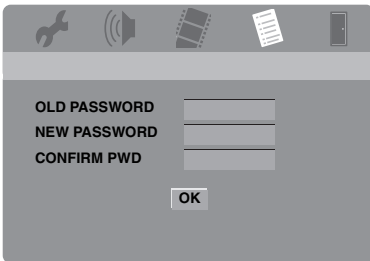

- 3 Use the **numeric buttons (0-9)** to enter your old six-digit password.
 - When doing this for the first time, enter “000 000”.
 - If you forget your old six-digit password, enter “000 000”.

- 4 Enter the new six-digit password.
- 5 Enter the new six-digit password again to confirm the password.
- 6 Press **ENTER** to confirm your new password.
 - The new six-digit password is now valid.

Resetting the system

You can reset all options and your personal settings to the initial factory settings, excluding [PASSWORD], [PARENTAL], and [DISC LOCK].



- 1 In “PREFERENCE PAGE”, press ▲/▼ to highlight [DEFAULT], and then press ► to select [RESET].
- 2 Press **ENTER**.
 - All settings are reset to the initial factory settings.







These codes can be used to select other languages. This does not affect the options in “AUDIO”, “SUBTITLE”, or “DISC MENU”.

Abkhazian	6566	Gaelic	7168	Macedonian	7775	Sardinian	8367
Afar	6565	Gallegan	7176	Malagasy	7771	Scottish Gaelic	7168
Afrikaans	6570	Georgian	7565	Malay	7783	Serbian	8382
Albanian	8381	German	6869	Malayalam	7776	Shona	8378
Amharic	6577	Gikuyu	7573	Maltese	7784	Sindhi	8368
Arabic	6582	Greek	6976	Manx	7186	Sinhalese	8373
Armenian	7289	Guarani	7178	Maori	7773	Slovak	8375
Assamese	6583	Gujarati	7185	Marathi	7782	Slovenian	8376
Avestan	6569	Hausa	7265	Marshallese	7772	Somali	8379
Aymara	6589	Hebrew	7269	Moldavian	7779	Sotho, Southern	8384
Azerbaijani	6590	Herero	7290	Mongolian	7778	South Ndebele	7882
Bashkir	6665	Hindi	7273	Nauru	7865	Spanish	6983
Basque	6985	Hiri Motu	7279	Navaho	7886	Sundanese	8385
Belarusian	6669	Hungarian	7285	Navajo	7886	Swahili	8387
Bengali	6678	Icelandic	7383	Ndebele, North	7868	Swati	8383
Bihari	6672	Ido	7379	Ndebele, South	7882	Swedish	8386
Bislama	6673	Indonesian	7368	Ndonga	7871	Tagalog	8476
Bokmål, Norwegian	7866	Interlingua (International)	7365	Nepali	7869	Tahitian	8489
Bosnian	6683	Interlingue	7369	Northern Sami	8369	Tajik	8471
Breton	6682	Inuktitut	7385	North Ndebele	7868	Tamil	8465
Bulgarian	6671	Inupiaq	7375	Norwegian	7879	Tatar	8484
Burmese	7789	Irish	7165	Norwegian Bokmål	7866	Telugu	8469
Castilian	6983	Italian	7384	Norwegian Nynorsk	7878	Thai	8472
Catalan	6765	Japanese	7465	Nyanja	7889	Tibetan	6679
Chamorro	6772	Javanese	7486	Nynorsk, Norwegian	7878	Tigrinya	8473
Chechen	6769	Kalaallisut	7576	Occitan (post 1500)	7967	Tonga (Tonga Islands)	8479
Chewa	7889	Kannada	7578	Old Bulgarian	6785	Tsong	8483
Chichewa	7889	Kashmiri	7583	Old Church Slavonic	6785	Tswana	8478
Chinese	9072	Kazakh	7575	Old Slavonic	6785	Turkish	8482
Chuang	9065	Khmer	7577	Oriya	7982	Turkmen	8475
Church Slavic	6785	Kikuyu	7573	Oromo	7977	Twi	8487
Church Slavonic	6785	Kinyarwanda	8287	Ossetian	7983	Uighur	8571
Chuvash	6786	Kirghiz	7589	Ossetic	7983	Ukrainian	8575
Cornish	7587	Komi	7586	Pali	8073	Urdu	8582
Corsican	6779	Korean	7579	Panjabi	8065	Uzbek	8590
Croatian	7282	Kuanyama	7574	Persian	7065	Vietnamese	8673
Czech	6783	Kurdish	7585	Polish	8076	Volapük	8679
Danish	6865	Kwanyama	7574	Portuguese	8084	Walloon	8765
Dutch	7876	Lao	7679	Provençal	7967	Welsh	6789
Dzongkha	6890	Latin	7665	Pushto	8083	Wolof	8779
English	6978	Latvian	7686	Quechua	8185	Xhosa	8872
Esperanto	6979	Letzeburgesch	7666	Raeto-Romance	8277	Yiddish	8973
Estonian	6984	Limburgan	7673	Romanian	8279	Yoruba	8979
Faroese	7079	Limburger	7673	Rundi	8278	Zhuang	9065
Fijian	7074	Limburgish	7673	Russian	8285	Zulu	9085
Finnish	7073	Lingala	7678	Samoan	8377		
French	7082	Lithuanian	7684	Sango	8371		
Frisian	7089	Luxembourgish	7666	Sanskrit	8365		

Troubleshooting

Refer to the chart below when this unit does not function properly. If the problem you are experiencing is not listed below or if the instruction below does not help, set this unit to the standby mode, disconnect the power cable, and contact the nearest authorized Yamaha dealer or service center.

Problem	Solution
No power	Connect the AC power cable properly.
	Press STANDBY/ON on the front panel to turn on the power.
This unit cannot read CD or DVD	Use a commonly available CD/DVD lens cleaner to clean the lens before sending this unit for repair.
“NO DISC” appears in the front panel display	Check that the disc is placed in the disc tray correctly.
“UN DISC” appears in the front panel display	The disc being loaded is not supported by this unit. Check the disc type (see “Playable disc formats” on page 4).
Disc or file does not play	The CD-R/RW, DVD+R/RW/R DL, and DVD-R/RW/R DL must be finalized.
	Check that the disc label is facing up.
	Check whether the disc is defective by trying another disc.
	If you have recorded a JPEG, MP3, or WMA disc yourself, check that your disc contains at least ten JPEG picture files or five MP3/WMA music tracks.
	Check the region code (see “Region codes” on page 3).
	For MP3/WMA, check that the sampling rate and bit rate are compatible.
	For JPEG, check that the resolution is compatible (see “Specifications” on page 48).
	For WMA/WMV, check that the file is not protected by DRM (Digital Rights Management).
	For WMV, check that the file has been encoded by WMV9.
	For WMV, check that the file is not Advanced Profile.
For WMV, check that the resolution of the file is 720 x 480/720 x 576 pixels or less.	
No picture	Refer to the manual supplied with your TV to select the video input channel correctly. Change the TV channel until you see the DVD screen.
	Turn on your TV.
	Check the video connection.
No picture is displayed when you make HDMI connections (using the HDMI jacks)	Follow the steps below to change the [HDMI VIDEO] to [AUTO]. <ol style="list-style-type: none"> 1. Press OPEN/CLOSE () on the front panel or press and hold  on the remote control to open the disc tray. 2. Press  on the remote control. 3. Press SUBTITLE on the remote control.

Problem	Solution
No picture is displayed when you do not use progressive scan connections (using the component video jacks)	<p>Follow the steps below to turn off the progressive scan.</p> <ol style="list-style-type: none"> 1. Press OPEN/CLOSE () on the front panel or press and hold  on the remote control to open the disc tray. 2. Press  on the remote control. 3. Press ZOOM on the remote control to deactivate the progressive scan.
Completely distorted picture, black/white picture, or no picture	<p>Check that the disc is compatible with this unit (see “Playable disc formats” on page 4).</p> <p>Check that the TV type of this unit is set to match that of the disc and your TV (see “Setting a color system for your TV” on page 14). Follow the steps below to change the setting of [TV TYPE].</p> <ol style="list-style-type: none"> 1. Press OPEN/CLOSE () on the front panel or press and hold  on the remote control to open the disc tray. 2. Press  on the remote control. 3. Press AUDIO on the remote control.
Distorted picture	<p>Occasionally, a small amount of picture distortion may appear depending on the disc being played back. This is not a malfunction.</p> <p>Check the video connection.</p>
Picture freezes momentarily during playback	<p>Check the disc for fingerprints/scratches and clean it with a soft cloth wiping from center to edge.</p> <p>For WMV/DivX®, lowering the bit rate may improve the problem.</p>
HD JPEG pictures cannot be displayed	<p>Check that [HD JPEG] is set to [ON] (see page 37).</p> <p>The disc reading time may exceed 30 seconds.</p> <p>MP3 music and HD JPEG pictures cannot be played simultaneously.</p>
The screen size looks unnatural, or the caption is displayed only partially on the TV monitor or is not displayed at all	<p>Check that the TV setting of this unit matches the screen size of your TV (see “Setting the TV display” on page 33).</p> <p>Change the screen size and the aspect ratio of your TV.</p>
No sound or distorted sound	<p>Adjust the volume.</p> <p>Check that the speakers are connected correctly.</p> <p>Check the audio connection.</p> <p>For MP3/WMA, check that the sampling rate and bit rate are compatible with this unit (see “Specifications” on page 48).</p> <p>For WMV/DivX®, record the file onto your USB device at a lower bit rate.</p>
No audio at digital output	<p>Check the digital connections.</p> <p>If you are playing a DTS source, check that your receiver can decode DTS, and that [DIGITAL OUTPUT] is set to [ALL] (see page 32).</p> <p>Check that the audio format of the selected audio language matches your receiver capabilities.</p>
No sound during DivX® movie playback	<p>The audio code may not be supported by this unit.</p>
This unit does not respond to the remote control	<p>Aim the remote control directly at the remote control sensor on the front panel.</p> <p>Reduce the distance of the remote control from this unit.</p> <p>Replace the batteries in the remote control.</p> <p>Reinsert the batteries with their polarities (+/- signs) as indicated.</p>

Troubleshooting

Problem	Solution
Buttons do not work	To completely reset this unit, unplug the AC cord from the AC outlet for 5-10 seconds, plug the AC cord to the AC outlet again, and then turn on this unit.
This unit does not respond to some operating commands during playback	Some operations may not be permitted by the disc. Refer to the instructions of the disc jacket.
Menu items cannot be selected	Press ■ twice on the remote control before selecting the setup menu.
	Depending on the disc availability, some menu items cannot be selected.
Your USB device cannot be recognized	Check that your USB device is connected correctly.
	Some devices may not be used even if they are USB mass storage class devices.
	Set this unit to the standby mode, and then turn it on again.
	Disconnect your USB device when this unit is in the standby mode, then connect it again and turn on this unit.
	Connect the AC adapter if the adapter is supplied with your USB device.
	If “Device not supported” appears on the TV screen, check whether your USB device is supported by this unit (see “Supported USB devices” on page 23).
	If “USB current protection active. Device not supported” appears on the TV screen, your USB device is not usable with this unit (see “Supported USB devices” on page 23).
This unit does not record CD tracks onto your USB device	Check that your USB device is connected correctly.
	Check that your USB device is compatible with this unit.
	Tracks protected by SCMS (Serial Copy Management System) are not recordable.
	Copy protected music discs incompatible with CDDA standard are not recordable.

Problem	Solution
<p>This unit stops recording CD tracks onto your USB device</p>	<p>If “Max files reached” appears on the TV screen, delete any files you do not need or create a new folder and then move some files to the created folder so that the number of files on a root directory in your USB device is reduced. This unit can record up to 648 files on each root directory. In case the above message appears, press ENTER to cancel the recording.</p>
	<p>If “USB full” appears on the TV screen, delete any files you do not need so that there is enough space in your USB device. In case the above message appears, press ENTER to cancel the recording.</p>
	<p>If “Max tracks reached” appears on the TV screen, rename “TRACK999” by using PC, etc. or create a new folder and then move the file to the created folder. In case the above message appears, press ENTER to cancel the recording.</p>
	<p>If “USB device error” appears on the TV screen, check the connection between this unit and the USB device. In case the above message appears, press ENTER to cancel the recording.</p>
	<p>If “Disc error” appears on the TV screen, check the disc for fingerprints/scratches and clean it with a soft cloth wiping from center to edge. In case the above message appears, press ENTER to cancel the recording.</p>
	<p>If “Copy protected” appears on the TV screen, check that the track is not protected by SCMS (Serial Copy Management System). Tracks protected by SCMS are not recordable. In case the above message appears, press ENTER to cancel the recording.</p>
<p>The MP3 file recorded on your USB device by using “MP3 RECORD” does not play or stops during playback</p>	<p>If the recording has been canceled, playback stops at the canceled point. Try recording again.</p>
	<p>If “USB full”, “USB device error”, or “Disc error” has appeared on the TV screen during the recording, created files cannot be played. Refer to “This unit stops recording CD tracks onto your USB device” to solve the problem and then try recording again.</p>
<p>The sound of recorded music on your USB device is low-quality, skips, or contains unexpected noise</p>	<p>Check the CD (e.g., sound quality, noise, or fingerprints/scratches).</p>

Glossary

■ Analog

Sound that has not been converted into numerical values. Analog sound varies, while digital sound has specific numerical values. These jacks send audio through two channels, the left and right.

■ Aspect ratio

The ratio of vertical and horizontal sizes of a displayed image. The horizontal vs. vertical ratio of conventional TVs is 4:3, and that of wide-screens is 16:9.

■ Audio output jacks

Jacks on the back of the DVD player that send audio to another system (TV, Stereo, etc.).

■ Bit rate

The amount of data used to hold a given length of music, measured in kilobits per seconds, or kbps. Or, the speed at which you record. Generally, the higher the bit rate, or the higher the recording speed, the better the sound quality. However, higher bit rates use more space on a disc.

■ Chapter

Sections of a picture or a music piece on a DVD that are smaller than titles. A title is composed of several chapters. Each chapter is assigned a chapter number enabling you to locate the chapter you want.

■ Component video output jacks

Jacks on the back of the DVD player that send high-quality video to a TV that has component video input jacks (R/G/B, Y/Pb/Pr, etc.).

■ Disc menu

A screen display prepared for allowing selection of images, sounds, subtitles, multi-angles, etc. recorded on a DVD.

■ Digital

Sound that has been converted into numerical values. Digital sound is available when you use the digital audio output jacks. These jacks send audio through multiple channels, instead of just two channels as analog does.

■ DivX®

DivX® is a popular media technology created by DivX, Inc. DivX® media files contain highly compressed video with high visual quality that maintains a relatively small file size. DivX® files can also include advanced media features like menus, subtitles, and alternate audio tracks. Many DivX® media files are available for download online, and you can create your own using your personal content and easy-to-use tools from DivX.com.

■ DivX® Ultra

DivX® Ultra Certified products provide enhanced playback of advanced media features supported by the DivX® Media Format. Key features include interactive video menus, subtitles, alternate audio tracks, video tags, and chapter points.

■ DMF (DivX® Media Format)

The DivX® Media Format supports advanced media features, adding controls for an interactive media experience: interactive video menus, chapter points, multi-language subtitles, and alternate audio tracks.

■ Dolby Digital

A surround sound system developed by Dolby Laboratories containing up to six channels of digital audio (front left and right, surround left and right, center and subwoofer).

■ DTS

Digital Theatre Systems. This is a surround sound system, but it is different from Dolby Digital. The formats were developed by different companies.

■ HDCP

HDCP (High-bandwidth Digital Content Protection) developed by Intel corporation, is a method to encrypt digital video and audio data for purpose of content protection. For further information on HDCP, visit the HDCP website at "www.digital-cp.com".

■ HD JPEG

HD (High-Definition) JPEG provides images in their enhanced resolution via HDMI connection.

■ HDMI

HDMI (High-Definition Multimedia Interface) is the first industry-supported, uncompressed, all-digital A/V (audio/video) interface. Providing an interface between any A/V source (such as a set-top box or A/V receiver) and an audio/video monitor (such as a digital television-DTV), HDMI supports standard, enhanced or high-definition video as well as multi-channel digital audio using a single cable. HDMI transmits all ATSC (Advanced Television Systems Committee) HDTV standards and supports 8-channel digital audio, with bandwidth extra to accommodate future enhancements and requirements.

When used in combination with HDCP (High-bandwidth Digital Content Protection), HDMI provides a secure audio/video interface that meets the security requirements of content providers and system operations. For further information on HDMI, visit the HDMI website at "www.hdmi.org/".

■ Interactive menu

Interactive video menus offer unprecedented convenience and control so you can quickly navigate between various scenes or bonus features, and select from audio track and subtitle options.

■ JPEG

A very common digital still picture format. A still-picture data compression system proposed by the Joint Photographic Expert Group, which features small decrease in image quality in spite of its high compression ratio.

■ MP3

A file format with a sound data compression system. "MP3" is the abbreviation of Motion Picture Experts Group 1 (or MPEG-1) Audio Layer 3. By using MP3 format, one CD-R or CD-RW can contain about ten times as much data as a regular CD can.

■ Parental control

A function of the DVD to limit playback of the disc by the age of the users according to the limitation level in each country. The limitation varies from disc to disc; when it is activated, playback will be prohibited if the software's level is higher than the user-set level.

■ PCM (Pulse Code Modulation)

A system for converting analog sound signals to digital signals for later processing, with no data compression used in conversion.

■ Playback control (PBC)

Refers to the signal recorded on video CDs or SVCDs for controlling reproduction. By using menu screens recorded on a Video CD or SVCD that supports PBC, you can enjoy interactive-type software as well as software having a search function.

■ Play list

A list of selected titles to be played back in a specific order. This option is only available with VR format and must be created beforehand.

■ Progressive scan

It displays all the horizontal lines of a picture at one time, as a signal frame. This system can convert the interlaced video from DVD into progressive format for connection to a progressive display. It dramatically increases the vertical resolution.

■ Region code

A system for allowing discs to be played back only in the region designated beforehand. This unit will only play discs that have compatible region codes. You can find the region code of your unit by looking on the product label. Some discs are compatible with more than one region (or ALL regions).

■ S-video

Produces a clear picture by sending separate signals for the luminance and the color. You can use S-video only if your TV has S-video input jack.

■ Surround

A system for creating realistic three dimensional sound fields full of realism by arranging multiple speakers around the listener.

■ Title

The longest section of a picture or music feature on DVD, music, etc., in video software, or the entire album in audio software. Each title is assigned a title number enabling you to locate the title you want.

■ Video output jack

Jack on the back of the DVD player that sends video to a TV.

■ VR (Video Recording) format

A format which enables you to create a DVD disc that can be extensively re-edited.

Specifications

PLAYABLE DISC FORMATS

- DVD-Video
- DVD-R, DVD-RW, DVD-R DL
- DVD+R, DVD+RW, DVD+R DL
- Video CD, SVCD
- CD
- PICTURE CD
- CD-R, CD-RW
- MP3 (ISO 9660)
 - fs 32, 44.1, 48 kHz..... 96-320 kbps
- WMA
 - fs 44.1 kHz..... 64-192 kbps
 - fs 48 kHz..... 128-192 kbps
- WMV 720 x 480/720 x 576 pixels or less
- DivX®
- JPEG..... 3072 x 2048 pixels or less

VIDEO PERFORMANCE

- Video (CVBS) output..... 1 Vpp into 75 ohm
- S-Video output Y: 1 Vpp into 75 ohm
C: 0.3 Vpp into 75 ohm
- Component video output..... Y: 1 Vpp into 75 ohm
PB/CB (PB), PR/CR (PR): 0.7 Vpp into 75 ohm
- RGB (Scart) output (Europe and Russia models only)
..... Y: 0.7 Vpp into 75 ohm

AUDIO FORMAT

- Digital
 - Dolby Digital, DTS..... Compressed digital
 - PCM..... fs 44.1, 48, 96 kHz/16, 20, 24 bits
- Analog sound Stereo

AUDIO PERFORMANCE

- DA Converter 24 bit
- Signal-Noise (1 kHz) 105 dB
- Dynamic range (1 kHz) 97 dB
- DVD fs 96 kHz, 2 Hz-44 kHz/fs 48 kHz, 2 Hz-22 kHz
- SVCD fs 48 kHz, 2 Hz-22 kHz/
fs 44.1 kHz, 2 Hz-20 kHz
- CD, VCD..... fs 44.1 kHz, 2 Hz-20 kHz
- Distortion and Noise (1 kHz) 0.0035%

MULTIMEDIA APPLICATIONS

- Connections USB mass storage class device
- Playback formats (USB device)
 - MP3..... fs 32, 44.1, 48 kHz/96-320 kbps
 - WMA..... fs 44.1 kHz/64-192 kbps,
fs 48 kHz/128-192 kbps
 - WMV 720 x 480/720 x 576 pixels or less
 - DivX®
 - JPEG 3072 x 2048 pixels or less

TV STANDARD

- Number of lines PAL: 625, NTSC: 525
- Vertical frequency..... PAL: 50 Hz, NTSC: 60 Hz
- Playback..... Multi-standard (PAL/NTSC)

CONNECTIONS

- Video output RCA/Phono x 1 (yellow)
- S-video output..... Mini DIN, 4 pins x 1
- Component video output
 - Y output RCA/Phono x 1 (green)
 - PB/CB (PB) output..... RCA/Phono x 1 (blue)
 - PR/CR (PR) output..... RCA/Phono x 1 (red)
- SCART (Europe and Russia models only)
Euroconnector x 1
- Audio output (L+R) RCA/Phono x 1 pair (white/red)
- Digital output
 - Coaxial..... RCA/Phono x 1
(IEC60958 for CDDA, LPCM /
IEC61937 for Dolby Digital, DTS)
 - HDMI..... Type A x 1
- USB Type A x 1
- Remote Control
 - Input..... ϕ 3.5 mm mini jack x 1
 - Output ϕ 3.5 mm mini jack x 1

CABINET

- Dimensions (W x D x H) 435 x 310 x 51 mm
(17-1/8 x 12-3/16 x 2 in)
- Weight..... Approx. 2.6 kg (5 lbs 12 oz)

POWER SUPPLY

- Power inlet
 - U.S.A. and Canada models..... AC 120 V, 60 Hz
 - Europe and Russia models..... AC 230 V, 50 Hz
 - Asia, and Central and South America models
..... AC 110-240 V, 50 Hz/60 Hz
 - Australia model..... AC 230-240 V, 50 Hz
 - Korea model AC 110-240 V, 60 Hz
- Power consumption..... Approx. 16 W
- Standby power consumption..... Less than 1 W

LASER

Type	Semiconductor laser GaAs/GaAlAs
Wave length	650 nm (DVD) 780 nm (VCD/CD)
Output Power	7 mW (DVD) 10 mW (VCD/CD)
Beam divergence	60 degrees

Specifications are subject to change without prior notice.

